

SL20 MEDIUM WELL LIGHT

SL20MD

PROJECT:

TYPE:

DATE:

CATALOG NUMBER:



SL20MDLLEDM303040



SL20MDGLEDM303040BRT



SL20MDLLEDM303040BRT with FA135MD (Eyebrow)

CATALOG ORDER LOGIC

EXAMPLE: SL20MDGNLMBAB

FIXTURE

SL Specialty Light

SERIES

20

SIZE

MD Medium

OPTIONS

- L Lens Holder
- G Grate

120 VOLT LED

WATT	SOCKET	BEAM ANGLE	KELVIN	LUMEN
<input type="checkbox"/> NL (No Lamp)	~	None	~	~
<input type="checkbox"/> NLMB	~	E26 Medium Base	~	~
<input type="checkbox"/> L144 (PAR20)	8w	E26 Medium Base	15°	3000K 600lm
<input type="checkbox"/> L146 (PAR20)	8w	E26 Medium Base	36°	3000K 600lm

120-277 VOLT LED

WATT	SOCKET	BEAM ANGLE	KELVIN	LUMEN
<input type="checkbox"/> L140 (PAR20)	8w	E26 Medium Base	15°	3000K 600lm
<input type="checkbox"/> L142 (PAR20)	8w	E26 Medium Base	36°	3000K 600lm

120 VOLT LED

WATT	SOCKET	KELVIN	LUMEN
<input type="checkbox"/> LEDM7	7w	~	2800K 560lm
<input type="checkbox"/> LEDM11	11w	~	2800K 960lm
<input type="checkbox"/> LEDM15	15w	~	2800K 1280lm
<input type="checkbox"/> LEDM20	20w	~	2800K 1800lm

120 VOLT LED

WATT	SOCKET	KELVIN	LUMEN
<input type="checkbox"/> LEDM30	30w	~	2700K 2600lm
<input type="checkbox"/> LEDM30	30w	~	3000K 3000lm

OPTICS (Optics for LED module only)

- 15 (15° Spot)
- 40 (40° Narrow Flood)
- 60 (60° Flood)
- 160 (160° Wide Flood, No Optic)

INTERNAL OPTIONS

- AB Aiming Bracket (To be used with NLMB version)

FINISH (standard finishes listed)

- BRT (Aluminum- Bronze Texture)
- BLT (Aluminum- Black Texture)
- BRS (Unfinished- Brass)

Premium and Acid Finishes (See page 4 for more color options)

Pantone & RAL Colors (Enter RAL or Pantone number at end of part number)

WEIGHT

Aluminum (2.0lbs)
 Brass (3.0lbs)

ADDITIONAL INFORMATION



landscape • architectural • hospitality • entertainment • illumination

FOCUS INDUSTRIES INC.
 25301 COMMERCENTRE DRIVE
 LAKE FOREST, CA. 92630
 949.830.1350 | TOLL FREE: 888.882.1350
 WWW.FOCUSINDUSTRIES.COM

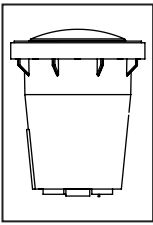

SL20 MEDIUM WELI LIGHT

SL20MD

PROJECT:

TYPE:

DATE:

CATALOG NUMBER:

DIMENSIONS

Dimensions Shown with Lens Holder

Place 3in Minimum Above Grade

Dimensions Shown with Grate

Place 3in Minimum Above Grade

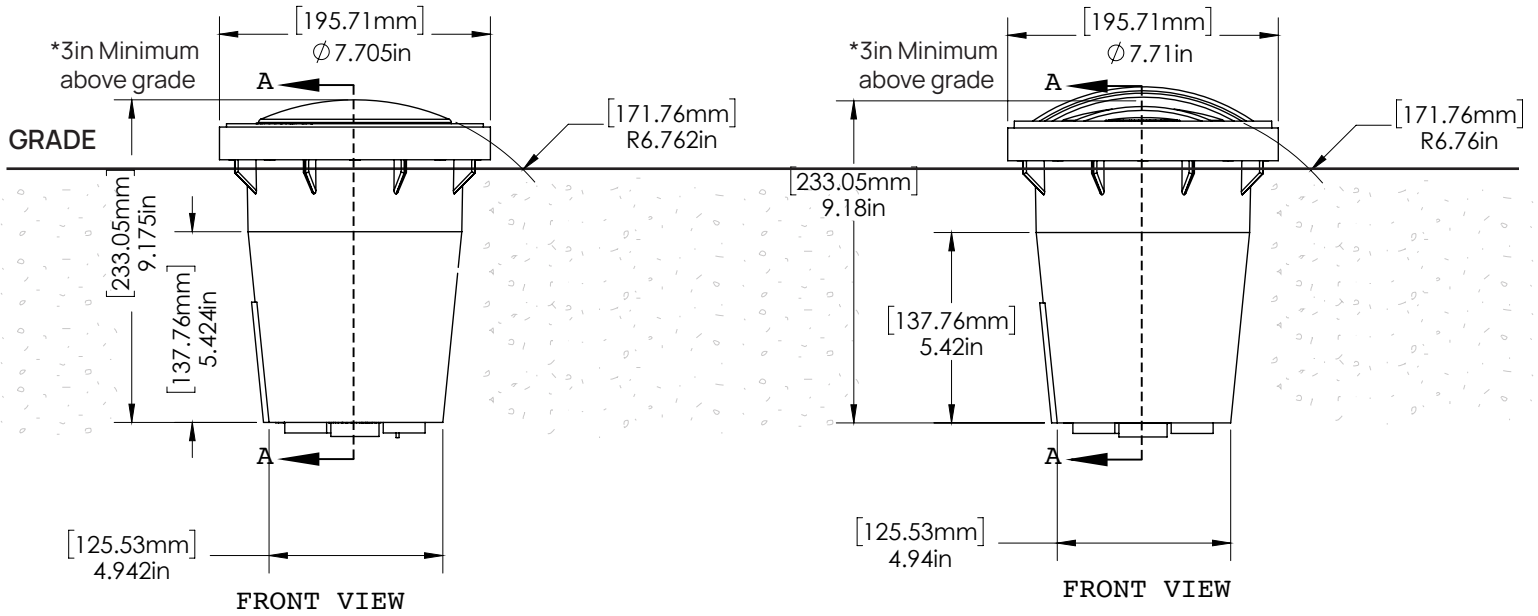

landscape • architectural • hospitality • entertainment • illumination

FOCUS INDUSTRIES INC.
25301 COMMERCENTRE DRIVE
LAKE FOREST, CA. 92630
949.830.1350 | TOLL FREE: 888.882.1350
WWW.FOCUSINDUSTRIES.COM

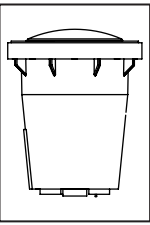

SL20 MEDIUM WELL LIGHT

SL20MD

PROJECT:

TYPE:

DATE:

CATALOG NUMBER:

SPECIFICATIONS

INTERNALS	VOLTAGE	120v-277v
	WATTAGE	8w PAR20 LED, 30 LED Module
	LED	PAR20: (L140[120-277v], L142[120-277v], L144[120v], L146[120v]), 7w LED Module: LEDM7 [12v], 11w LED Module: LEDM11 [12v], 15w LED Module: LEDM15 [12v], 20w LED Module: LEDM20 [12v] 30w LED module [120v]
	LUMENS	PAR20: 600lm, 7w LED Module: 560lm, 11w LED Module: 960lm, 15w LED Module: 1280lm, 20w LED Module: 1800lm LED Module: 2600lm (27k) / 3000lm (3k)
	WIRING	120v: 18g black, white, and green (ground)
	GASKET	Close cell sponge, 4.75" square x .190"th, center cut out, 2 holes, PSA 1-side
	SOCKET	E26 medium base (For PAR20 version only)
	BRACKET	Medium base 120v adjustable bracket assembly (For Par20 version only)
EXTERNALS	BUCKET	Composite BMC Bronze well light bucket
	MATERIALS	Aluminum, Brass, Composite
	LENS	Convex glass lens, clear tempered, 155mm x 28mm, ±.5mm
	FINISH	Aluminum: Standard finishes (BLT/BRT: Black or Bronze texture) More finishes available, see page 5 Brass: Standard unfinished (Acid treatments available, see page 5)
	LISTINGS	IP65. Indoor/Outdoor use. Suitable for wet locations

IP65



Click Icon to Download



landscape • architectural • hospitality • entertainment • illumination

FOCUS INDUSTRIES INC.
 25301 COMMERCENTRE DRIVE
 LAKE FOREST, CA. 92630
 949.830.1350 | TOLL FREE: 888.882.1350
 WWW.FOCUSINDUSTRIES.COM

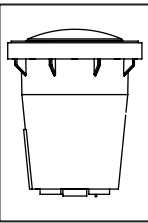

SL20 MEDIUM WELI LIGHT

SL20MD

PROJECT:

TYPE:

DATE:

CATALOG NUMBER:

ACCESSORIES

(Configure and order accessories separately)

Lenses



FA35SL20MDRED
(Red Color Glass Lens)



FA35SL20MDAMBER
(Amber Color Glass Lens)



FA35SL20MDGREEN
(Green Color Glass Lens)



FA35SL20MDBLUE
(Blue Color Glass Lens)



FA10SGSL20MDSB
(Sand Blasted Lens)



FA08SL20MD
(Hex Cell Louver)



FA10SGSL20MD
(Clear Flat Glass Lens)

Lens Holders & Eyebrows

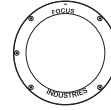

FA133-BLT/-BRS
(Blue Color Glass Lens)

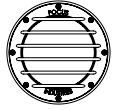

FA134-BLT/-BRS
(Blue Color Glass Lens)



FA135-BLT / -BRS
(Blue Color Glass Lens)

Trims

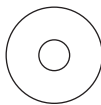

FA133MDTR
(Clear Flat Glass Lens)



landscape • architectural • hospitality • entertainment • illumination

FOCUS INDUSTRIES INC.
25301 COMMERCENTRE DRIVE
LAKE FOREST, CA. 92630
949.830.1350 | TOLL FREE: 888.882.1350
WWW.FOCUSINDUSTRIES.COM

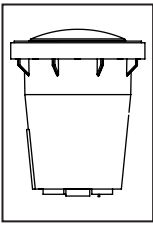

SL20 MEDIUM WELI LIGHT

SL20MD

PROJECT: _____ TYPE: _____ DATE: _____

CATALOG NUMBER: _____

LED DATA

120v PAR20 DATA

L#	CCT	CRI	WATTS	LUMENS	RATED HOURS	VOLTAGE
L144	3000K	80+	8	600	25,000	120V
L146	3000K	80+	8	600	25,000	120V

120-277v PAR20 DATA

L#	CCT	CRI	WATTS	LUMENS	RATED HOURS	VOLTAGE
L140	3000K	80+	8	600	50,000	120-277V
L142	3000K	80+	8	600	50,000	120-277V

120v LED MODULE DATA

L#	CCT	CRI	WATTS	LUMENS	RATED HOURS	VOLTAGE
LEDM30	2700K	70+	30	2600	50,000	120V
LEDM30	3000K	80+	30	3000	50,000	120V

OPTICS

OPTICS	ANGLE
SP - Spot	15°
FL - Flood	40°
WFL - Wide Flood	60°
VWFL - Very Wide Flood	160° No Optics

FINISHES

STANDARD FINISHES

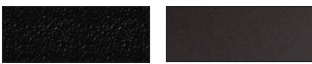

Black Texture (-BLT)

Bronze Texture (-BRT)

PREMIUM FINISHES



Black Magic (-BKM)

Dark Bronze (-DBZ)

CUSTOM FINISHES Supply RAL or Pantone here

RAL #: _____

Need help finding a RAL color?
<https://www.ralcolor.com/>

PANTONE #: _____

Need help finding a Pantone color?
<https://www.pantone.com/color-finder>

OPTIONAL POWDER COAT FINISHES

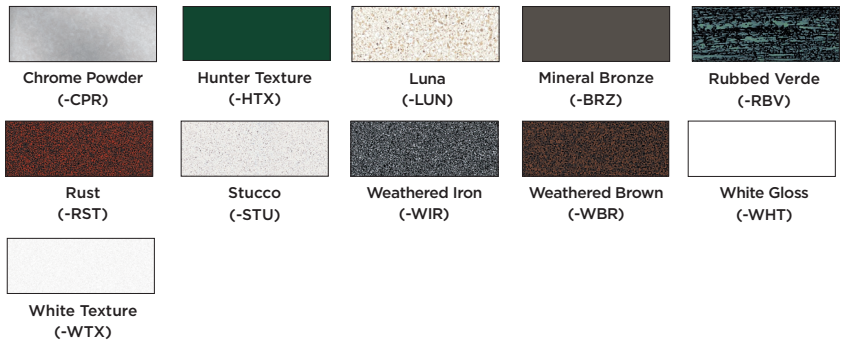

ACID FINISHES Brass and Copper fixtures only

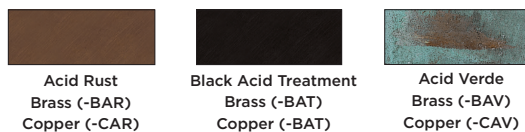

SCAN FOR FULL SIZE COLOR SWATCHES



landscape • architectural • hospitality • entertainment • illumination

FOCUS INDUSTRIES INC.
25301 COMMERCENTRE DRIVE
LAKE FOREST, CA. 92630
949.830.1350 | TOLL FREE: 888.882.1350
WWW.FOCUSINDUSTRIES.COM