



landscape • architectural • hospitality • entertainment • illumination

DESIGNED
MANUFACTURED
IN THE USA



NEW SUPPLEMENTAL LIST PRICE GUIDE 2021

A complete price guide to Focus Industries New Products



SL64DL24BRT



AL08MDDMS2L24BRSBKM



LFL01LEDM1027MVBLT



SL1510S2AL24CAR



SL58LGHORLEDSWBR



PL26LGDMCD010L24BLT

landscape • architectural • hospitality • entertainment • illumination



SUPPLEMENTAL LIST PRICE GUIDE 2021

TO PLACE ORDERS:
ORDERS@FOCUSINDUSTRIES.COM
TOLL FREE (888)882.1350

MORE INFORMATION ON FOCUS PRODUCTS
DOWNLOAD OUR BROCHURES
WWW.FOCUSINDUSTRIES.COM

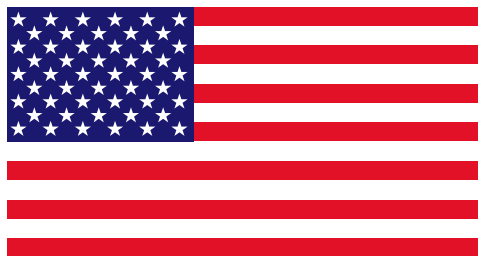

DESIGNED & MANUFACTURED
IN THE USA

TABLE OF CONTENTS

■ AREA LIGHTING.....	4-6
AL08 S2 BOLLARDS	4-6
■ DIRECTIONAL LIGHTING.....	7-8
DL50 PAR30/DL50LEDM	7
DL60 PAR36 / DL50 AR111.....	8
■ FLAG POLE.....	9
FLAG POLE RING.....	9
■ FLOOD LIGHTING.....	10-12
DL10 LEDM	10
LFLO1LEDM.....	10
LFLO1LEDM (2', 3', 4', 6', 8').....	11-12
■ HANGING LIGHTING / PENDANT LIGHTING	13-21
SL15 "STARLIGHT" HANGING FIXTURES	13
SL15 "STARLIGHT" PENDENTS.....	15
RXS CYLINDER PENDENTS	17-21
■ PATH LIGHTING.....	21-31
PL23 / PL23LEDP.....	21-22
PL23 S1/S2/S3/S4 BOLLARDS.....	24-25
PL23LG SERIES.....	26
PL23LG S1/S2/S3/S4	27-30
PL26 ISLAND STYLE BOLLARD	31
PL26 ADDRESS BOLLARD.....	32
■ SPECIALTY LIGHTING.....	33
SL37 BOCCE BALL.....	33
■ STEP/BRICK LIGHTING	33
SL62 LEDM.....	33
■ SURFACE MOUNTS.....	34-48
RXS CYLINDER SURFACE MOUNTS.....	34-38
SL63 2X2 SQUARE SURFACE MOUNTS	39-42
SL63 LG 4X4 SQUARE SURFACE MOUNTS.....	43-44
SL58	45
SL58SMLEDM	45
SL58SMHORLEDS.....	46
SL58LGHORLEDS	46
SL64SM "CUBE"	47
SL64 "CUBE"	47
SL65SM	48
SL65MD.....	48
■ FINISH OPTIONS.....	49
■ LED LIST PRICE GUIDE	50-52

Area Lighting



TO PLACE ORDERS
ORDERS@FOCUSINDUSTRIES.COM
TOLL FREE (888)882.1350

MORE INFORMATION ON FOCUS PRODUCTS
DOWNLOAD OUR BROCHURES
WWW.FOCUSINDUSTRIES.COM

*Prices subject to change. Consult factory for pricing, questions or inquiries.

12V AL085M	BOLLARD	MATERIAL	FINISH	LED	CCT/LM	SOCKET	CURRENT LIST PRICE USD\$
1.5" DIA X 12" 360° 12V SMALL BOLLARD WITH FROSTED ACRYLIC ACCENT, DECK MOUNT, FA03 MOUNTING STAKE (INCLUDED)							
	AL08SMDMS2L4COP	COPPER	UNFINISHED	2W OMNI MINI LED	3000K/180LM	G4	\$151.80
	AL08SMDMS2L74COP	COPPER	UNFINISHED	1.5W MR8 LED	3000K/65LM	G4	\$155.10
FINISHES: (SEE PAGE 49 FOR MORE INFORMATION)							
	ADD ON COST FOR OPTIONAL COLOR FINISHES						\$11.00
	ADD ON COST FOR PREMIUM COLOR BKM						\$19.80
	ADD ON COST FOR PREMIUM COLOR DBZ						\$17.60
	ADD ON COST FOR ACID TREATMENT OF COPPER						\$33.00
*NOTE: CUSTOM PRODUCT CONFIGURATIONS, PAINT FINISHES, AND ACID TREATMENTS ARE AVAILABLE; BUT NON RETURNABLE							
MOUNTING DEVICE:							
	FA03 - BLACK ABS STAKE, 1/2" NPS FEMALE THREADED						\$5.50
OPTIONAL MOUNTING DEVICES:							
	FA03RXBRS - RX REMEDY 7" BRASS STAKE, 1/2" NPS FEMALE THREADED						\$20.90
	FA032PBLK - 2 PRONG STAKE, STAINLESS STEEL, 1/2" NPS FEMALE THREADED BLACK						\$43.75
OPTIONAL CANOPY FOR MOUNTING:							
	FA24BRS - BRASS SINGLE 1/2" NPS THREADED ROUND MINI CANOPY						\$30.80
	FA24MDCSTBRS - BRASS ROUND CANOPY, 1/2" NPS FEMALE, 2 MATCHING MOUNTING SCREWS						\$30.80
COLOR GLASS LENS OPTIONS:							
	FA1017AMBER - AMBER TEMPERED GLASS LENS 1.4" OD X 0.125" ± 0.03" TH						\$27.50
	FA1017RED - RED TEMPERED GLASS LENS 1.4" OD X 0.125" ± 0.03" TH						\$27.50
	FA1017BLUE - BLUE TEMPERED GLASS LENS 1.4" OD X 0.125" ± 0.03" TH						\$27.50
	FA1017GREEN - GREEN TEMPERED GLASS LENS 1.4" OD X 0.125" ± 0.03" TH						\$27.50
TO HAVE COLOR LENS INSTALLED ADD: (A) FOR AMBER (R) FOR RED (B) FOR BLUE (G) FOR GREEN, TO PART NUMBER AND ADD \$27.50 TO FIXTURE PRICE							

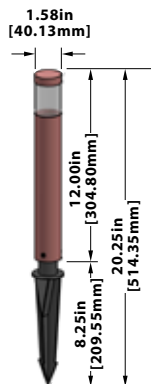

12V-277V AL08MDDM	BOLLARD	MATERIAL	FINISH	LED	CCT/LM	SOCKET	CURRENT LIST PRICE USD\$
2.5" DIA X 18" 360° 12V MEDIUM BOLLARD WITH FROSTED ACRYLIC ACCENT, DECK MOUNT, FA03LG MOUNTING STAKE INCLUDED							
	AL08MDDMS2L24BLT	ALUMINUM	BLACK TEXTURE	3W MR16 SS LED 36°	3000K/270LM	GU5.3	\$198.00
	AL08MDDMS2L24BRS	BRASS	UNFINISHED	3W MR16 SS LED 36°	3000K/270LM	GU5.3	\$283.80
	AL08MDDMS2L24COP	COPPER	UNFINISHED	3W MR16 SS LED 36°	3000K/270LM	GU5.3	\$288.20
2.5" DIA X 18" 360° 120V MEDIUM BOLLARD WITH FROSTED ACRYLIC ACCENT, DECK MOUNT							
	AL08MDDMS2L108BLT	ALUMINUM	BLACK TEXTURE	3W MR16 SS LED 36°	3000K/270LM	GU10	\$212.30
	AL08MDDMS2L108BRS	BRASS	UNFINISHED	3W MR16 SS LED 36°	3000K/270LM	GU10	\$298.10
	AL08MDDMS2L108COP	COPPER	UNFINISHED	3W MR16 SS LED 36°	3000K/270LM	GU10	\$302.50
FINISHES: (SEE PAGE 49 FOR MORE INFORMATION)							
	ADD ON COST FOR OPTIONAL COLOR FINISHES						\$11.00
	ADD ON COST FOR PREMIUM COLOR BKM						\$19.80
	ADD ON COST FOR PREMIUM COLOR DBZ						\$17.60
	ADD ON COST FOR ACID TREATMENT OF BRASS AND COPPER						\$33.00
*NOTE: CUSTOM PRODUCT CONFIGURATIONS, PAINT FINISHES, AND ACID TREATMENTS ARE AVAILABLE; BUT NON RETURNABLE							
MOUNTING DEVICE:							
	FA03LG - LARGE BLACK ABS STAKE, 1/2" NPS FEMALE THREADED						\$13.20
OPTIONAL MOUNTING DEVICES:							
	FA033PBLK - 3 PRONG STAKE, STAINLESS STEEL, 1/2" NPS FEMALE THREADED, BLACK						\$56.25
	FAJBOX - CAST BRASS JUNCTION BOX, 1/2" NPS FEMALE THREADED ON COVER						\$198.00
	FA25BLT - 12V PVC MOUNTING PEDESTAL, ALUMINUM CAP, BLACK TEXTURE						\$55.00
	FA25BRS - 12V PVC MOUNTING PEDESTAL, BRASS CAP						\$75.90
	FA26BLT - 120V PVC MOUNTING PEDESTAL, ALUMINUM CAP, BLACK TEXTURE						\$56.10
	FA26BRS - 120V PVC MOUNTING PEDESTAL, BRASS CAP						\$79.20
COLOR GLASS LENS OPTIONS:							
	FA1133AMBER - AMBER TEMPERED GLASS LENS 2" OD X 0.125" ± 0.03" TH						\$20.90
	FA1133RED - RED TEMPERED GLASS LENS 2" OD X 0.125" ± 0.03" TH						\$20.90
	FA1133BLUE - BLUE TEMPERED GLASS LENS 2" OD X 0.125" ± 0.03" TH						\$20.90
	FA1133GREEN - GREEN TEMPERED GLASS LENS 2" OD X 0.125" ± 0.03" TH						\$20.90
TO HAVE COLOR LENS INSTALLED ADD: (A) FOR AMBER (R) FOR RED (B) FOR BLUE (G) FOR GREEN, TO PART NUMBER AND ADD \$20.90 TO FIXTURE PRICE							

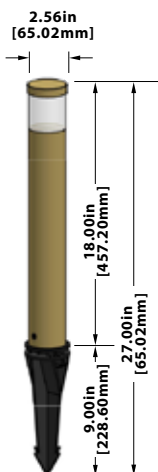

12V-277V AL08MD	BOLLARD	MATERIAL	FINISH	LED	CCT/LM	SOCKET	CURRENT LIST PRICE USD\$
--------------------	---------	----------	--------	-----	--------	--------	--------------------------------

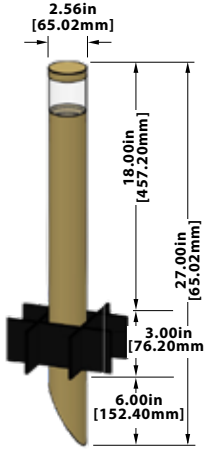

2.5" DIA X 18" 360° 12V MEDIUM BOLLARD WITH FROSTED ACRYLIC ACCENT, ANGLE CUT, 4 MOUNTING FINNS INCLUDED

AL08MDS2L24BRS	BRASS	UNFINISHED	3W MR16 SS LED 36°	3000K/270LM	GU5.3	\$284.90
AL08MDS2L24COP	COPPER	UNFINISHED	3W MR16 SS LED 36°	3000K/270LM	GU5.3	\$336.60

2.5" DIA X 18" 360° 120V MEDIUM BOLLARD WITH FROSTED ACRYLIC ACCENT, ANGLE CUT, 4 MOUNTING FINNS INCLUDED

AL08MDS2L108BRS	BRASS	UNFINISHED	3W MR16 SS LED 36°	3000K/270LM	GU10	\$299.20
AL08MDS2L108COP	COPPER	UNFINISHED	3W MR16 SS LED 36°	3000K/270LM	GU10	\$350.90

FINISHES: (SEE PAGE 49 FOR MORE INFORMATION)

ADD ON COST FOR OPTIONAL COLOR FINISHES	\$11.00
ADD ON COST FOR PREMIUM COLOR BKM	\$19.80
ADD ON COST FOR PREMIUM COLOR DBZ	\$17.60
ADD ON COST FOR ACID TREATMENT OF BRASS AND COPPER	\$33.00

*NOTE: CUSTOM PRODUCT CONFIGURATIONS, PAINT FINISHES, AND ACID TREATMENTS ARE AVAILABLE; BUT NON RETURNABLE

MOUNTING DEVICE:

FA42FIN - BLACK PLASTIC MOUNTING FINNS (PACK OF 4)	\$14.30
--	---------

COLOR GLASS LENS OPTIONS:

FA1133AMBER - AMBER TEMPERED GLASS LENS 2" OD X 0.125" ± 0.03"TH	\$20.90
FA1133RED - RED TEMPERED GLASS LENS 2" OD X 0.125" ± 0.03"TH	\$20.90
FA1133BLUE - BLUE TEMPERED GLASS LENS 2" OD X 0.125" ± 0.03"TH	\$20.90
FA1133GREEN - GREEN TEMPERED GLASS LENS 2" OD X 0.125" ± 0.03"TH	\$20.90

TO HAVE COLOR LENS INSTALLED ADD: (A) FOR AMBER (R) FOR RED (B) FOR BLUE (G) FOR GREEN, TO PART NUMBER AND ADD \$20.90 TO FIXTURE PRICE



POWER SUPPLY:

120V-277V USES P/N HW1260LED277R1 TRANSFORMER INSTALLED IN WEATHERPROOF JUNCTION BOX NO MORE THAN 18' FROM FIXTURE	\$99.00
--	---------



12V-277V AL08LG	BOLLARD	MATERIAL	FINISH	LED	CCT/LM	SOCKET	CURRENT LIST PRICE USD\$
--------------------	---------	----------	--------	-----	--------	--------	-----------------------------

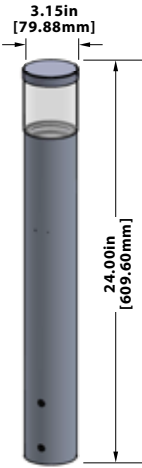

3" DIA X 24" 360° 12V LARGE BOLLARD WITH FROSTED ACRYLIC ACCENT, DECK MOUNT, STAINLESS STEEL U-BRACKET INCLUDED

AL08LGDMS2L24BLT	ALUMINUM	BLACK TEXTURE	3W MR16 SS LED 36°	3000K/270LM	GU5.3	\$242.00
AL08LGDMS2L24BRS	BRASS	UNFINISHED	3W MR16 SS LED 36°	3000K/270LM	GU5.3	\$379.50

3" DIA X 24" 360° 120V LARGE BOLLARD WITH FROSTED ACRYLIC ACCENT, DECK MOUNT, STAINLESS STEEL U-BRACKET INCLUDED

AL08LGDMS2L108BLT	ALUMINUM	BLACK TEXTURE	3W MR16 SS LED 36°	3000K/270LM	GU10	\$256.30
AL08LGDMS2L108BRS	BRASS	UNFINISHED	3W MR16 SS LED 36°	3000K/270LM	GU10	\$393.80

FINISHES: (SEE PAGE 49 FOR MORE INFORMATION)

ADD ON COST FOR OPTIONAL COLOR FINISHES	\$16.50
ADD ON COST FOR PREMIUM COLOR BKM	\$29.70
ADD ON COST FOR PREMIUM COLOR DBZ	\$26.40
ADD ON COST FOR ACID TREATMENT OF BRASS	\$49.50

*NOTE: CUSTOM PRODUCT CONFIGURATIONS, PAINT FINISHES, AND ACID TREATMENTS ARE AVAILABLE; BUT NON RETURNABLE

MOUNTING DEVICE:

FACPUBSS - STAINLESS STEEL U BRACKET FOR DECK MOUNT 3" DIA	\$62.50
--	---------

OPTIONAL MOUNTING DEVICES:

FA033PBLK - 3 PRONG STAKE, STAINLESS STEEL, 1/2" NPS FEMALE THREADED, BLACK	\$56.25
FAJBOX - CAST BRASS JUNCTION BOX, 1/2" NPS FEMALE THREADED ON COVER	\$198.00
FA25BLT - 12V PVC MOUNTING PEDESTAL, ALUMINUM CAP, BLACK TEXTURE	\$55.00
FA25BRS - 12V PVC MOUNTING PEDESTAL, BRASS CAP	\$75.90
FA26BLT - 120V PVC MOUNTING PEDESTAL, ALUMINUM CAP, BLACK TEXTURE	\$56.10
FA26BRS - 120V PVC MOUNTING PEDESTAL, BRASS CAP	\$79.20

COLOR GLASS LENS OPTIONS:

FA1133AMBER - AMBER TEMPERED GLASS LENS 2" OD X 0.125" ± 0.03"TH	\$20.90
FA1133RED - RED TEMPERED GLASS LENS 2" OD X 0.125" ± 0.03"TH	\$20.90
FA1133BLUE - BLUE TEMPERED GLASS LENS 2" OD X 0.125" ± 0.03"TH	\$20.90
FA1133GREEN - GREEN TEMPERED GLASS LENS 2" OD X 0.125" ± 0.03"TH	\$20.90

TO HAVE COLOR LENS INSTALLED ADD: (A) FOR AMBER (R) FOR RED (B) FOR BLUE (G) FOR GREEN, TO PART NUMBER AND ADD \$20.90 TO FIXTURE PRICE

12V-277V AL08LG	BOLLARD	MATERIAL	FINISH	LED	CCT/LM	SOCKET	CURRENT LIST PRICE USD\$
--------------------	---------	----------	--------	-----	--------	--------	-----------------------------

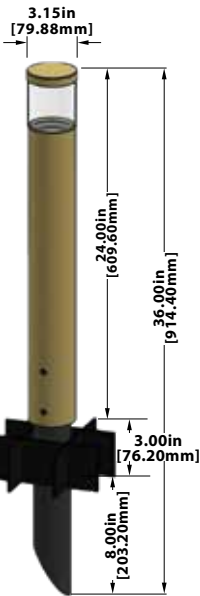

3" DIA X 24" 360° 12V LARGE BOLLARD WITH FROSTED ACRYLIC ACCENT, ANGLE CUT, BLACK ABS STAKE MOUNT, 4 MOUNTING FINNS INCLUDED

AL08LGDMS2L24BLT	ALUMINUM	BLACK TEXTURE	3W MR16 SS LED 36°	3000K/270LM	GU5.3	\$226.60
AL08LGDMS2L24BRS	BRASS	UNFINISHED	3W MR16 SS LED 36°	3000K/270LM	GU5.3	\$341.00

3" DIA X 24" 360° 120V LARGE BOLLARD WITH FROSTED ACRYLIC ACCENT, ANGLE CUT, BLACK ABS STAKE MOUNT, 4 MOUNTING FINNS INCLUDED

AL08LGDMS2L108BLT	ALUMINUM	BLACK TEXTURE	3W MR16 SS LED 36°	3000K/270LM	GU10	\$240.90
AL08LGDMS2L108BRS	BRASS	UNFINISHED	3W MR16 SS LED 36°	3000K/270LM	GU10	\$355.30

FINISHES: (SEE PAGE 49 FOR MORE INFORMATION)

ADD ON COST FOR OPTIONAL COLOR FINISHES	\$16.50
ADD ON COST FOR PREMIUM COLOR BKM	\$29.70
ADD ON COST FOR PREMIUM COLOR DBZ	\$26.40
ADD ON COST FOR ACID TREATMENT OF BRASS	\$49.50

*NOTE: CUSTOM PRODUCT CONFIGURATIONS, PAINT FINISHES, AND ACID TREATMENTS ARE AVAILABLE; BUT NON RETURNABLE

MOUNTING DEVICE:

FA42FIN - BLACK PLASTIC MOUNTING FINNS (PACK OF 4)	\$14.30
--	---------

OPTIONAL MOUNTING DEVICES:

FA033PBLK - 3 PRONG STAKE, STAINLESS STEEL, 1/2" NPS FEMALE THREADED, BLACK	\$56.25
FAJBOX - CAST BRASS JUNCTION BOX, 1/2" NPS FEMALE THREADED ON COVER	\$198.00
FA25BLT - 12V PVC MOUNTING PEDESTAL, ALUMINUM CAP, BLACK TEXTURE	\$55.00
FA25BRS - 12V PVC MOUNTING PEDESTAL, BRASS CAP	\$75.90
FA26BLT - 120V PVC MOUNTING PEDESTAL, ALUMINUM CAP, BLACK TEXTURE	\$56.10
FA26BRS - 120V PVC MOUNTING PEDESTAL, BRASS CAP	\$79.20

COLOR GLASS LENS OPTIONS:

FA1133AMBER - AMBER TEMPERED GLASS LENS 2" OD X 0.125" ± 0.03"TH	\$20.90
FA1133RED - RED TEMPERED GLASS LENS 2" OD X 0.125" ± 0.03"TH	\$20.90
FA1133BLUE - BLUE TEMPERED GLASS LENS 2" OD X 0.125" ± 0.03"TH	\$20.90
FA1133GREEN - GREEN TEMPERED GLASS LENS 2" OD X 0.125" ± 0.03"TH	\$20.90

TO HAVE COLOR LENS INSTALLED ADD: (A) FOR AMBER (R) FOR RED (B) FOR BLUE (G) FOR GREEN, TO PART NUMBER AND ADD \$20.90 TO FIXTURE PRICE

POWER SUPPLY:

120V-277V USES P/N HW1260LED277R1 TRANSFORMERS INSTALLED IN WEATHERPROOF JUNCTION BOX NO MORE THAN 18' FROM FIXTURE	\$99.00
---	---------



Directional Lighting



TO PLACE ORDERS
 ORDERS@FOCUSINDUSTRIES.COM
 TOLL FREE (888)882.1350

MORE INFORMATION ON FOCUS PRODUCTS
 DOWNLOAD OUR BROCHURES
 WWW.FOCUSINDUSTRIES.COM

*Prices subject to change. Consult factory for pricing, questions or inquiries.

120V-277V DL50PAR30	DIRECTIONAL LIGHT	MATERIAL	FINISH	LED	CCT/LM	SOCKET	CURRENT LIST PRICE USD\$
------------------------	-------------------	----------	--------	-----	--------	--------	--------------------------

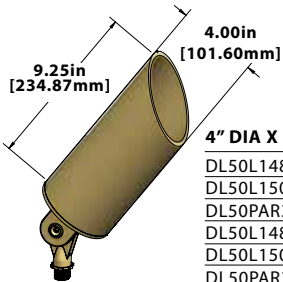

4" DIA X 9.25" ALUMINUM OR BRASS BULLET

DL50L148BLT	ALUMINUM	BLACK TEXTURE	12W PAR30 15°	3000K/1080LM	MEDIUM BASE	\$174.50
DL50L150BLT	ALUMINUM	BLACK TEXTURE	12W PAR30 40°	3000K/1080LM	MEDIUM BASE	\$174.50
DL50PAR30NLBLT	ALUMINUM	BLACK TEXTURE	NO LAMP		MEDIUM BASE	\$125.00
DL50L148BRS	BRASS	UNFINISHED	12W PAR30 15°	3000K/1080LM	MEDIUM BASE	\$324.50
DL50L150BRS	BRASS	UNFINISHED	12W PAR30 40°	3000K/1080LM	MEDIUM BASE	\$324.50
DL50PAR30NLBRS	BRASS	UNFINISHED	NO LAMP		MEDIUM BASE	\$275.00

FINISHES: (SEE PAGE 49 FOR MORE INFORMATION)

ADD ON COST FOR OPTIONAL FINISHES	\$11.00
ADD ON COST FOR PREMIUM COLOR BKM	\$19.80
ADD ON COST FOR PREMIUM COLOR DBZ	\$17.60
ADD ON COST FOR ACID TREATMENT OF BRASS	\$33.00

*NOTE: CUSTOM PRODUCT CONFIGURATIONS, PAINT FINISHES, AND ACID TREATMENTS ARE AVAILABLE; BUT NON RETURNABLE

MOUNTING DEVICES:

FA26BLT - 120V-277V ABS MOUNTING PEDESTAL, CAST ALUMINUM CAP, BLACK TEXTURE	\$56.10
FA26BRS - 120V-277V ABS MOUNTING PEDESTAL, CAST BRASS CAP, UNFINISHED	\$79.20
FAJBOX - BRASS JUNCTION BOX, 1/2" NPS FEMALE ON COVER	\$198.00

ACCESSORIES:

FA0806 - 3" DIA. X 1/4" MINI HEX CELL LOUVER	\$25.30
FA10450 - WIDE SPREAD/SOFTENERS LITE GLASS LENS	\$25.30
FA9850 - LINEAR SPREAD GLASS LENS	\$25.30

*NOTE: ALL 120V-277V FIXTURES MUST USE FA26 MOUNTING PEDESTAL OR WATERPROOF JUNCTION BOX

**NOTE: 25W, 120V, 2000 LUMEN / 30W, 120V, 2500 LUMEN, TO BE RELEASED LATER THIS YEAR

12V-277V DL50LEDM	DIRECTIONAL LIGHT	MATERIAL	FINISH	LED	CCT/LM	SOCKET	CURRENT LIST PRICE USD\$
----------------------	-------------------	----------	--------	-----	--------	--------	--------------------------

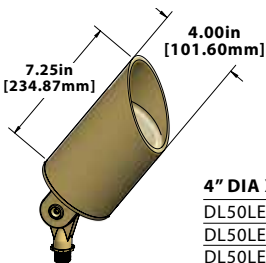

4" DIA X 7.25" ALUMINUM OR BRASS BULLET

DL50LEDM2015BLT	ALUMINUM	BLACK TEXTURE	20W LED MODULE 15°	3000K/1800LM	NONE	120-277v	\$297.00
DL50LEDM2040BLT	ALUMINUM	BLACK TEXTURE	20W LED MODULE 40°	3000K/1800LM	NONE	120-277v	\$297.00
DL50LEDM2060BLT	ALUMINUM	BLACK TEXTURE	20W LED MODULE 60°	3000K/1800LM	NONE	120-277v	\$297.00
DL50LEDM20WFBLT	ALUMINUM	BLACK TEXTURE	20W LED MODULE WF	3000K/1800LM	NONE	120-277v	\$275.00
DL50LEDM2015BRS	BRASS	UNFINISHED	20W LED MODULE 15°	3000K/1800LM	NONE	120-277v	\$418.00
DL50LEDM2040BRS	BRASS	UNFINISHED	20W LED MODULE 40°	3000K/1800LM	NONE	120-277v	\$418.00
DL50LEDM2060BRS	BRASS	UNFINISHED	20W LED MODULE 60°	3000K/1800LM	NONE	120-277v	\$418.00
DL50LEDM20WFBRS	BRASS	UNFINISHED	20W LED MODULE WF	3000K/1800LM	NONE	120-277v	\$396.00

FINISHES: (SEE PAGE 49 FOR MORE INFORMATION)

ADD ON COST FOR OPTIONAL FINISHES	\$11.00
ADD ON COST FOR PREMIUM COLOR BKM	\$19.80
ADD ON COST FOR PREMIUM COLOR DBZ	\$17.60
ADD ON COST FOR ACID TREATMENT OF BRASS	\$33.00

*NOTE: CUSTOM PRODUCT CONFIGURATIONS, PAINT FINISHES, AND ACID TREATMENTS ARE AVAILABLE; BUT NON RETURNABLE

MOUNTING DEVICES:

FA26BLT - 120V-277V ABS MOUNTING PEDESTAL, CAST ALUMINUM CAP, BLACK TEXTURE	\$56.10
FA26BRS - 120V-277V ABS MOUNTING PEDESTAL, CAST BRASS CAP, UNFINISHED	\$79.20
FAJBOX - BRASS JUNCTION BOX, 1/2" NPS FEMALE ON COVER	\$198.00

ACCESSORIES:

FA0806 - 3" DIA. X 1/4" MINI HEX CELL LOUVER	\$25.30
FA10450 - WIDE SPREAD/SOFTENERS LITE GLASS LENS	\$25.30
FA9850 - LINEAR SPREAD GLASS LENS	\$25.30

*NOTE: ALL 120V-277V FIXTURES MUST USE FA26 MOUNTING PEDESTAL OR WATERPROOF JUNCTION BOX

**NOTE: 25W, 120V, 2000 LUMEN / 30W, 120V, 2500 LUMEN, TO BE RELEASED LATER THIS YEAR

120V-277V DL60PAR38	DIRECTIONAL LIGHT	MATERIAL	FINISH	LED	CCT/LM	SOCKET	CURRENT LIST PRICE USD\$
------------------------	-------------------	----------	--------	-----	--------	--------	-----------------------------

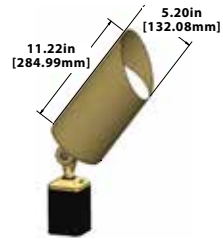

5.20" DIA X 11.22" ALUMINUM BULLET, ANGLE CUT, CONVEX LENS

DL60L156BLT	ALUMINUM	BLACK TEXTURE	15W PAR38 LED15°	3000K/1350LM	MEDIUM BASE	\$209.50
DL60L158BLT	ALUMINUM	BLACK TEXTURE	15W PAR38 LED 40°	3000K/1350LM	MEDIUM BASE	\$209.50
DL60LBLT	ALUMINUM	BLACK TEXTURE	NO LAMP	3000K/1350LM	NONE	\$149.00

FINISHES: (SEE PAGE 49 FOR MORE INFORMATION)

ADD ON COST FOR OPTIONAL FINISHES	\$11.00
ADD ON COST FOR PREMIUM COLOR BKM	\$19.80
ADD ON COST FOR PREMIUM COLOR DBZ	\$17.60
ADD ON COST FOR ACID TREATMENT OF BRASS	\$33.00

*NOTE: CUSTOM PRODUCT CONFIGURATIONS, PAINT FINISHES, AND ACID TREATMENTS ARE AVAILABLE; BUT NON RETURNABLE

MOUNTING DEVICES:

FA26BLT - 120V-277V ABS MOUNTING PEDESTAL, CAST ALUMINUM CAP, BLACK TEXTURE	\$56.10
FA26BRS - 120V-277V ABS MOUNTING PEDESTAL, CAST BRASS CAP, UNFINISHED	\$79.20
FAJBOX - BRASS JUNCTION BOX, 1/2" NPS FEMALE ON COVER	\$198.00

*NOTE: ALL 120V-277V FIXTURES MUST USE FA26 MOUNTING PEDESTAL OR WATERPROOF JUNCTION BOX

12V DL60AR111	DIRECTIONAL LIGHT	MATERIAL	FINISH	LED	CCT/LM	SOCKET	CURRENT LIST PRICE USD\$
------------------	-------------------	----------	--------	-----	--------	--------	-----------------------------



5.20" DIA X 7.22 ALUMINUM BULLET, ANGLE CUT, CONVEX LENS

DL60L69BLT	ALUMINUM	BLACK TEXTURE	15W AR111 LED 15°	3000K/1350LM	NONE	\$196.00
DL60L98BLT	ALUMINUM	BLACK TEXTURE	15W AR111 LED 40°	3000K/1350LM	NONE	\$196.00

FINISHES: (SEE PAGE 49 FOR MORE INFORMATION)

ADD ON COST FOR OPTIONAL FINISHES	\$11.00
ADD ON COST FOR PREMIUM COLOR BKM	\$19.80
ADD ON COST FOR PREMIUM COLOR DBZ	\$17.60
ADD ON COST FOR ACID TREATMENT OF BRASS	\$33.00

*NOTE: CUSTOM PRODUCT CONFIGURATIONS, PAINT FINISHES, AND ACID TREATMENTS ARE AVAILABLE; BUT NON RETURNABLE

MOUNTING DEVICES:

FA26BLT - 120V-277V ABS MOUNTING PEDESTAL, CAST ALUMINUM CAP, BLACK TEXTURE	\$56.10
FA26BRS - 120V-277V ABS MOUNTING PEDESTAL, CAST BRASS CAP, UNFINISHED	\$79.20
FAJBOX - BRASS JUNCTION BOX, 1/2" NPS FEMALE ON COVER	\$198.00

*NOTE: ALL 120V-277V FIXTURES MUST USE FA26 MOUNTING PEDESTAL OR WATERPROOF JUNCTION BOX

Flag Pole Ring



TO PLACE ORDERS
 ORDERS@FOCUSINDUSTRIES.COM
 TOLL FREE (888)882.1350

MORE INFORMATION ON FOCUS PRODUCTS
 DOWNLOAD OUR BROCHURES
 WWW.FOCUSINDUSTRIES.COM

*Prices subject to change. Consult factory for pricing, questions or inquiries.

12V-120V FAPM72H12V	FLAG POLE RING	MATERIAL	FINISH	CURRENT LIST PRICE USD\$
------------------------	----------------	----------	--------	-----------------------------

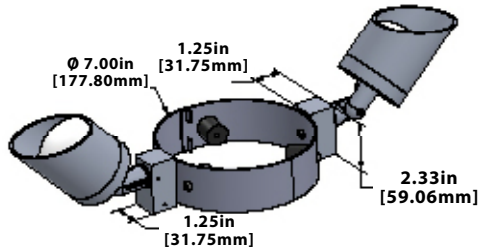

Shown with DL42 Directional Lights
 (Fixtures Sold Separately)

7" DIA POLE MOUNT RING, CAN FIT UP TO 3 FIXTURES (12v) (shown)

FAPM72H12VBLT	ALUMINUM	BLACK TEXTURE	\$110.00
FAPM72H12VBRS	BRASS	UNFINISHED	\$207.90

7" DIA POLE MOUNT RING, CAN FIT UP TO 3 FIXTURES (120v)

FAPM72H120VBLT	ALUMINUM	BLACK TEXTURE	\$146.30
FAPM72H120VBRS	BRASS	UNFINISHED	\$324.50

FINISHES: (SEE PAGE 49 FOR MORE INFORMATION)

ADD ON COST FOR OPTIONAL COLOR	\$11.00
ADD ON COST FOR PREMIUM COLOR BKM	\$19.80
ADD ON COST FOR PREMIUM COLOR DBZ	\$17.60

*NOTE: CUSTOM PRODUCT CONFIGURATIONS, PAINT FINISHES, AND ACID TREATMENTS ARE AVAILABLE; BUT NON RETURNABLE

120V-277V FAPM73H120V	FLAG POLE RING	MATERIAL	FINISH	CURRENT LIST PRICE USD\$
--------------------------	----------------	----------	--------	-----------------------------

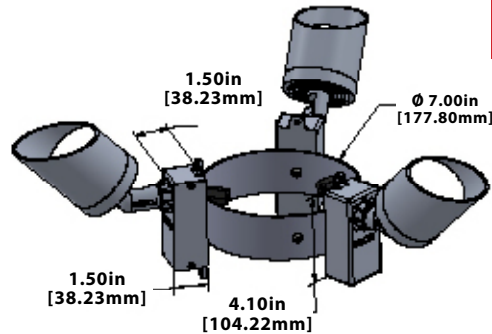

Shown with DL42 Directional Lights
 (Fixtures Sold Separately)

7" DIA POLE MOUNT RING. CAN FIT UP TO 3 FIXTURES 12V

FAPM73H12VBLT	ALUMINUM	BLACK TEXTURE	\$115.50
FAPM73H12VBRS	BRASS	UNFINISHED	\$245.30

7" DIA POLE MOUNT RING. CAN FIT UP TO 3 FIXTURES 120V (shown)

FAPM73H120VBLT	ALUMINUM	BLACK TEXTURE	\$156.20
FAPM73H120VBRS	BRASS	UNFINISHED	\$434.50

FINISHES: (SEE PAGE 49 FOR MORE INFORMATION)

ADD ON COST FOR OPTIONAL COLOR	\$11.00
ADD ON COST FOR PREMIUM COLOR BKM	\$19.80
ADD ON COST FOR PREMIUM COLOR DBZ	\$17.60

*NOTE: CUSTOM PRODUCT CONFIGURATIONS, PAINT FINISHES, AND ACID TREATMENTS ARE AVAILABLE; BUT NON RETURNABLE



POWER SUPPLY:

120V-277V USES P/N HW1260LED277R1 TRANSFORMER INSTALLED IN WEATHERPROOF JUNCTION BOX NO MORE THAN 18' FROM FIXTURE	\$99.00
--	---------

Flood Lighting

TO PLACE ORDERS
 ORDERS@FOCUSINDUSTRIES.COM
 TOLL FREE (888)882.1350

MORE INFORMATION ON FOCUS PRODUCTS
 DOWNLOAD OUR BROCHURES
 WWW.FOCUSINDUSTRIES.COM

*Prices subject to change. Consult factory for pricing, questions or inquiries.

120V-277V	DIRECTIONAL LIGHT	MATERIAL	FINISH	LED	CCT/LM	SOCKET	CURRENT LIST PRICE USD\$
-----------	-------------------	----------	--------	-----	--------	--------	--------------------------

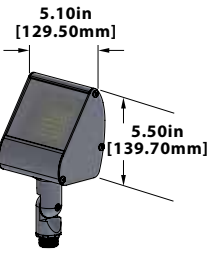

5.1" x 5.5" LED MODULE 160° DIRECTIONAL FLOOD LIGHT							
DL10LEDM3027MVBLT	ALUMINUM	BLACK TEXTURE	30W LED MODULE	2700K/2,800LM	NONE		\$126.50
DL10LEDM3030MVBLT	ALUMINUM	BLACK TEXTURE	30W LED MODULE	3000K/2,900LM	NONE		\$126.50
DL10LEDM3041MVBLT	ALUMINUM	BLACK TEXTURE	30W LED MODULE	4100K/3,000LM	NONE		\$126.50

FINISHES: (SEE PAGE 49 FOR MORE INFORMATION)							
ADD ON COST FOR OPTIONAL COLOR							\$11.00
ADD ON COST FOR PREMIUM COLOR BKM							\$19.80
ADD ON COST FOR PREMIUM COLOR DBZ							\$17.60
*NOTE: CUSTOM PRODUCT CONFIGURATIONS, PAINT FINISHES, AND ACID TREATMENTS ARE AVAILABLE; BUT NON RETURNABLE							

MOUNTING DEVICE:							
FA26BLT - 120V-277V ABS MOUNTING PEDESTAL, CAST ALUMINUM CAP, BLACK TEXTURE							\$56.10

OPTIONAL MOUNTING DEVICES:							
FA26BRS - 120V-277V ABS MOUNTING PEDESTAL, CAST BRASS CAP, UNFINISHED							\$79.20
FAJBOX - BRASS JUNCTION BOX, 1/2" NPS FEMALE ON COVER							\$198.00

HOOD EXTENSION OPTION:							
FA108BLT - ADD (HE) TO PART NUMBER							\$16.50

*NOTE: CUSTOM MODULE CONFIGURATIONS AVAILABLE 10W LED MODULE AT 2700K, 3000K, 4100K

120V-277V	FLOOD LIGHT	MATERIAL	FINISH	LED	CCT/LM	SOCKET	CURRENT LIST PRICE USD\$
-----------	-------------	----------	--------	-----	--------	--------	--------------------------

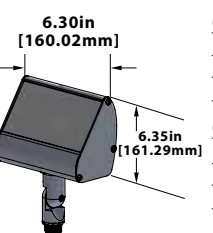

6.3" X 6.35" LED MODULE 160° FLOOD LIGHT							
LFL01LEDM1027MVBLT	ALUMINUM	BLACK TEXTURE	10W LED MODULE	2700K/860LM	NONE		\$82.50
LFL01LEDM1030MVBLT	ALUMINUM	BLACK TEXTURE	10W LED MODULE	3000K/900LM	NONE		\$82.50
LFL01LEDM1041MVBLT	ALUMINUM	BLACK TEXTURE	10W LED MODULE	4100K/1,500LM	NONE		\$82.50

6.3" X 6.35" LED MODULE 160° FLOOD LIGHT (WITH HOOD EXTENSION)							
LFL01HELEDM1027MVBLT	ALUMINUM	BLACK TEXTURE	10W LED MODULE	2700K/860LM	NONE		\$110.00
LFL01HELEDM1030MVBLT	ALUMINUM	BLACK TEXTURE	10W LED MODULE	3000K/900LM	NONE		\$110.00
LFL01HELEDM1041MVBLT	ALUMINUM	BLACK TEXTURE	10W LED MODULE	4100K/1,500LM	NONE		\$110.00

FINISHES: (SEE PAGE 49 FOR MORE INFORMATION)							
ADD ON COST FOR OPTIONAL COLOR							\$11.00
ADD ON COST FOR PREMIUM COLOR BKM							\$19.80
ADD ON COST FOR PREMIUM COLOR DBZ							\$17.60

*NOTE: CUSTOM PRODUCT CONFIGURATIONS, PAINT FINISHES, AND ACID TREATMENTS ARE AVAILABLE; BUT NON RETURNABLE
 **NOTE: CUSTOM MODULE CONFIGURATIONS AVAILABLE 30W LED MODULE AT 2700K, 3000K, 4100K

120V-277V	FLOOD LIGHT	MATERIAL	FINISH	LED	CCT/LM	SOCKET	CURRENT LIST PRICE USD\$
-----------	-------------	----------	--------	-----	--------	--------	--------------------------

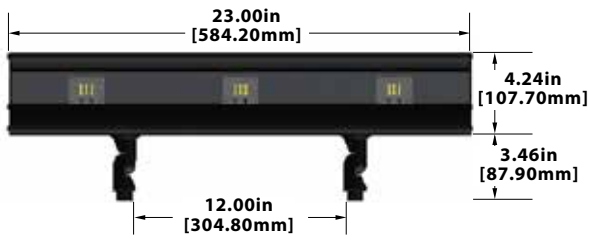

LED MODULE 160° FLOOD LIGHT 2FT (24")

LFL012LEDM1027MVBTL	ALUMINUM	BLACK TEXTURE	3X 10W LED MODULE	2700K/2,580LM	NONE	\$167.20
LFL012LEDM1030MVBTL	ALUMINUM	BLACK TEXTURE	3X 10W LED MODULE	3000K/2,700LM	NONE	\$167.20
LFL012LEDM1041MVBTL	ALUMINUM	BLACK TEXTURE	3X 10W LED MODULE	4100K/4,500LM	NONE	\$167.20

HOOD EXTENSION OPTION:

FA6924BLT - HOOD EXTENSION FOR LFL012 ADD -(HE) TO PART NUMBER	\$59.40
--	---------

FINISHES: (SEE PAGE 49 FOR MORE INFORMATION)

ADD ON COST FOR OPTIONAL COLOR FOR 2FT(24")	\$27.50
---	---------

*NOTE: CUSTOM PRODUCT CONFIGURATIONS, PAINT FINISHES, AND ACID TREATMENTS ARE AVAILABLE; BUT NON RETURNABLE

**NOTE: CUSTOM MODULE CONFIGURATIONS AVAILABLE 30W LED MODULE AT 2700K, 3000K, 4100K

120V-277V	FLOOD LIGHT	MATERIAL	FINISH	LED	CCT/LM	SOCKET	CURRENT LIST PRICE USD\$
-----------	-------------	----------	--------	-----	--------	--------	--------------------------



LED MODULE 160° FLOOD LIGHT 3FT (36")

LFL013LEDM1027MVBTL	ALUMINUM	BLACK TEXTURE	4X 10W LED MODULE	2700K/3,440LM	NONE	\$204.60
LFL013LEDM1030MVBTL	ALUMINUM	BLACK TEXTURE	4X 10W LED MODULE	3000K/3,600LM	NONE	\$204.60
LFL013LEDM1041MVBTL	ALUMINUM	BLACK TEXTURE	4X 10W LED MODULE	4100K/6,000LM	NONE	\$204.60

HOOD EXTENSION OPTION:

FA6939BLT - HOOD EXTENSION FOR LFL013 ADD -(HE) TO PART NUMBER	\$79.20
--	---------

FINISHES: (SEE PAGE 49 FOR MORE INFORMATION)

ADD ON COST FOR OPTIONAL COLOR FOR 3FT(36")	\$33.00
---	---------

*NOTE: CUSTOM PRODUCT CONFIGURATIONS, PAINT FINISHES, AND ACID TREATMENTS ARE AVAILABLE; BUT NON RETURNABLE

**NOTE: CUSTOM MODULE CONFIGURATIONS AVAILABLE 30W LED MODULE AT 2700K, 3000K, 4100K

120V-277V	FLOOD LIGHT	MATERIAL	FINISH	LED	CCT/LM	SOCKET	CURRENT LIST PRICE USD\$
-----------	-------------	----------	--------	-----	--------	--------	--------------------------

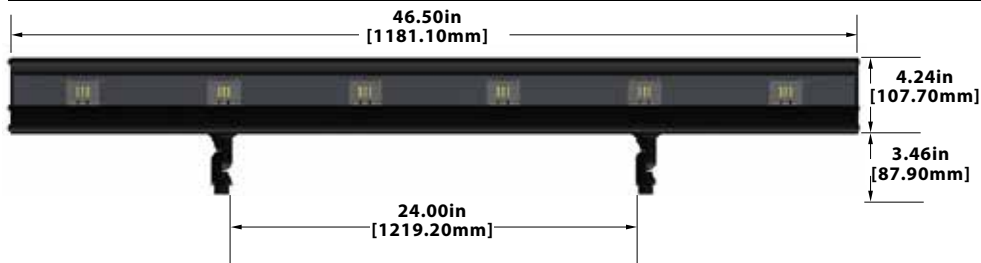

LED MODULE 160° FLOOD LIGHT 4FT (48")

LFL014LEDM1027MVBTL	ALUMINUM	BLACK TEXTURE	6X 10W LED MODULE	2700K/5,160LM	NONE	\$264.00
LFL014LEDM1030MVBTL	ALUMINUM	BLACK TEXTURE	6X 10W LED MODULE	3000K/5,400LM	NONE	\$264.00
LFL014LEDM1041MVBTL	ALUMINUM	BLACK TEXTURE	6X 10W LED MODULE	4100K/9,000LM	NONE	\$264.00

HOOD EXTENSION OPTION:

FA6954BLT - HOOD EXTENSION FOR LFL014 ADD -(HE) TO PART NUMBER	\$85.80
--	---------

FINISHES: (SEE PAGE 49 FOR MORE INFORMATION)

ADD ON COST FOR OPTIONAL COLOR FOR 4FT(48")	\$33.00
---	---------

*NOTE: CUSTOM PRODUCT CONFIGURATIONS, PAINT FINISHES, AND ACID TREATMENTS ARE AVAILABLE; BUT NON RETURNABLE

**NOTE: CUSTOM MODULE CONFIGURATIONS AVAILABLE 30W LED MODULE AT 2700K, 3000K, 4100K

120V-277V	FLOOD LIGHT	MATERIAL	FINISH	LED	CCT/LM	SOCKET	CURRENT LIST PRICE USD\$
-----------	-------------	----------	--------	-----	--------	--------	--------------------------



LED MODULE FLOOD LIGHT 6FT (72")

LFL016LEDM1027MVBLT	ALUMINUM	BLACK TEXTURE	9X 10W LED MODULE	2700K/7,740LM	NONE	\$511.50
LFL016LEDM1030MVBLT	ALUMINUM	BLACK TEXTURE	9X 10W LED MODULE	3000K/8,100LM	NONE	\$511.50
LFL016LEDM1041MVBLT	ALUMINUM	BLACK TEXTURE	9X 10W LED MODULE	4100K/13,500LM	NONE	\$511.50

FINISHES: (SEE PAGE 49 FOR MORE INFORMATION)

ADD ON COST FOR OPTIONAL COLOR FOR 6FT(72") \$44.00

*NOTE: CUSTOM PRODUCT CONFIGURATIONS, PAINT FINISHES, AND ACID TREATMENTS ARE AVAILABLE; BUT NON RETURNABLE

**NOTE: CUSTOM MODULE CONFIGURATIONS AVAILABLE 30W LED MODULE AT 2700K, 3000K, 4100K

120V-277V	FLOOD LIGHT	MATERIAL	FINISH	LED	CCT/LM	SOCKET	CURRENT LIST PRICE USD\$
-----------	-------------	----------	--------	-----	--------	--------	--------------------------

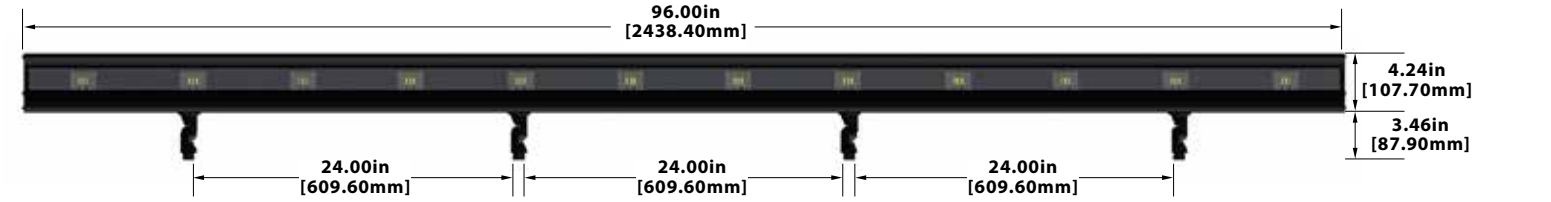

LED MODULE FLOOD LIGHT 8FT (96")

LFL018LEDM1027MVBLT	ALUMINUM	BLACK TEXTURE	12X 10W LED MODULE	2700K/10,320LM	NONE	\$819.50
LFL018LEDM1030MVBLT	ALUMINUM	BLACK TEXTURE	12X 10W LED MODULE	3000K/10,800LM	NONE	\$819.50
LFL018LEDM1041MVBLT	ALUMINUM	BLACK TEXTURE	12X 10W LED MODULE	4100K/18,000LM	NONE	\$819.50

FINISHES: (SEE PAGE 49 FOR MORE INFORMATION)

ADD ON COST FOR OPTIONAL COLOR FOR 8FT(96") \$55.00

*NOTE: CUSTOM PRODUCT CONFIGURATIONS, PAINT FINISHES, AND ACID TREATMENTS ARE AVAILABLE; BUT NON RETURNABLE

**NOTE: CUSTOM MODULE CONFIGURATIONS AVAILABLE 30W LED MODULE AT 2700K, 3000K, 4100K

Hanging Lighting



TO PLACE ORDERS
ORDERS@FOCUSINDUSTRIES.COM
TOLL FREE (888)882.1350

MORE INFORMATION ON FOCUS PRODUCTS
DOWNLOAD OUR BROCHURES
WWW.FOCUSINDUSTRIES.COM

*Prices subject to change. Consult factory for pricing, questions or inquiries.

12V	HANGING LIGHT	MATERIAL	FINISH	LED	CCT/LM	SOCKET	CURRENT LIST PRICE USD\$
-----	---------------	----------	--------	-----	--------	--------	--------------------------

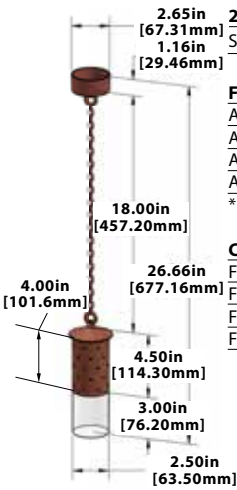

2.5" DIA X 4" COPPER CYLINDER "STARLIGHT" HANGING FIXTURE WITH 3" FROSTED ACRYLIC ACCENT, 2.65" CANOPY, 18" BRASS CHAIN							
SL15S2L12COP	COPPER	UNFINISHED	3W OMNI SS LED	3000K/300LM	BA15S		\$203.50

FINISHES: (SEE PAGE 49 FOR MORE INFORMATION)

ADD ON COST FOR OPTIONAL FINISHES	\$22.00
ADD ON COST FOR PREMIUM COLOR BKM	\$39.60
ADD ON COST FOR PREMIUM COLOR DBZ	\$35.20
ADD ON COST FOR ACID TREATMENT OF COPPER	\$66.00

*NOTE: CUSTOM PRODUCT CONFIGURATIONS, PAINT FINISHES, AND ACID TREATMENTS ARE AVAILABLE; BUT NON RETURNABLE

COLOR GLASS LENS OPTIONS:

FA1133AMBER - AMBER TEMPERED GLASS LENS 2"OD X 0.125" ± 0.03"TH	\$20.90
FA1133RED - RED TEMPERED GLASS LENS 2"OD X 0.125" ± 0.03"TH	\$20.90
FA1133BLUE - BLUE TEMPERED GLASS LENS 2"OD X 0.125" ± 0.03"TH	\$20.90
FA1133GREEN - GREEN TEMPERED GLASS LENS 2"OD X 0.125" ± 0.03"TH	\$20.90

12V	HANGING LIGHT	MATERIAL	FINISH	LED	CCT/LM	SOCKET	CURRENT LIST PRICE USD\$
-----	---------------	----------	--------	-----	--------	--------	--------------------------

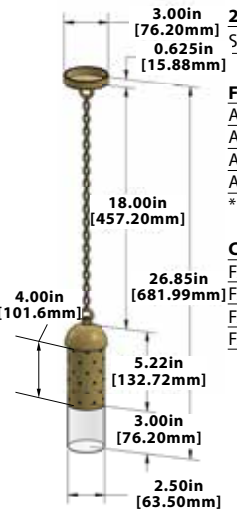

2.5" DIA X 4" BRASS CYLINDER "STARLIGHT" HANGING FIXTURE WITH 3" FROSTED ACRYLIC ACCENT, 3" CANOPY, 18" BRASS CHAIN							
SL15S2L12BRS	BRASS	UNFINISHED	3W OMNI SS LED	3000K/300LM	BA15S		\$215.60

FINISHES: (SEE PAGE 49 FOR MORE INFORMATION)

ADD ON COST FOR OPTIONAL FINISHES	\$22.00
ADD ON COST FOR PREMIUM COLOR BKM	\$39.60
ADD ON COST FOR PREMIUM COLOR DBZ	\$35.20
ADD ON COST FOR ACID TREATMENT OF BRASS	\$66.00

*NOTE: CUSTOM PRODUCT CONFIGURATIONS, PAINT FINISHES, AND ACID TREATMENTS ARE AVAILABLE; BUT NON RETURNABLE

COLOR GLASS LENS OPTIONS:

FA1133AMBER - AMBER TEMPERED GLASS LENS 2"OD X 0.125" ± 0.03"TH	\$20.90
FA1133RED - RED TEMPERED GLASS LENS 2"OD X 0.125" ± 0.03"TH	\$20.90
FA1133BLUE - BLUE TEMPERED GLASS LENS 2"OD X 0.125" ± 0.03"TH	\$20.90
FA1133GREEN - GREEN TEMPERED GLASS LENS 2"OD X 0.125" ± 0.03"TH	\$20.90

12V								CURRENT LIST PRICE USD\$
-----	--	--	--	--	--	--	--	--------------------------

SL1510S2COP

HANGING LIGHT

MATERIAL

FINISH

LED

CCT/LM

SOCKET

CURRENT LIST PRICE USD\$

2.5" DIA X 10" COPPER CYLINDER "STARLIGHT" HANGING FIXTURE WITH 3" FROSTED ACRYLIC ACCENT, 2.65" CANOPY, 18" BRASS CHAIN

SL1510S2L24COP	COPPER	UNFINISHED	3W MR16 SS LED 36°	3000K/270LM	GU5.3	\$298.10
----------------	--------	------------	--------------------	-------------	-------	----------

FINISHES: (SEE PAGE 49 FOR MORE INFORMATION)

ADD ON COST FOR OPTIONAL FINISHES	\$22.00
ADD ON COST FOR PREMIUM COLOR BKM	\$39.60
ADD ON COST FOR PREMIUM COLOR DBZ	\$35.20
ADD ON COST FOR ACID TREATMENT OF COPPER	\$66.00

*NOTE: CUSTOM PRODUCT CONFIGURATIONS, PAINT FINISHES, AND ACID TREATMENTS ARE AVAILABLE; BUT NON RETURNABLE

COLOR GLASS LENS OPTIONS:

FA1133AMBER - AMBER TEMPERED GLASS LENS 2"OD X 0.125" ± 0.03"TH	\$20.90
FA1133RED - RED TEMPERED GLASS LENS 2"OD X 0.125" ± 0.03"TH	\$20.90
FA1133BLUE - BLUE TEMPERED GLASS LENS 2"OD X 0.125" ± 0.03"TH	\$20.90
FA1133GREEN - GREEN TEMPERED GLASS LENS 2"OD X 0.125" ± 0.03"TH	\$20.90

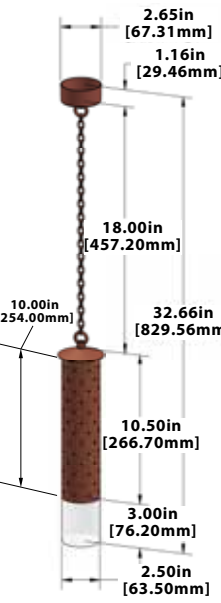

12V								CURRENT LIST PRICE USD\$
-----	--	--	--	--	--	--	--	--------------------------

SL1510S2BRS

HANGING LIGHT

MATERIAL

FINISH

LED

CCT/LM

SOCKET

CURRENT LIST PRICE USD\$

2.5" DIA X 10" BRASS CYLINDER "STARLIGHT" HANGING FIXTURE WITH 3" FROSTED ACRYLIC ACCENT, 3" CANOPY, 18" BRASS CHAIN

SL1510S2L24BRS	BRASS	UNFINISHED	3W MR16 SS LED 36°	3000K/270LM	GU5.3	\$305.80
----------------	-------	------------	--------------------	-------------	-------	----------

FINISHES: (SEE PAGE 49 FOR MORE INFORMATION)

ADD ON COST FOR OPTIONAL FINISHES	\$22.00
ADD ON COST FOR PREMIUM COLOR BKM	\$39.60
ADD ON COST FOR PREMIUM COLOR DBZ	\$35.20
ADD ON COST FOR ACID TREATMENT OF BRASS	\$66.00

*NOTE: CUSTOM PRODUCT CONFIGURATIONS, PAINT FINISHES, AND ACID TREATMENTS ARE AVAILABLE; BUT NON RETURNABLE

COLOR GLASS LENS OPTIONS:

FA1133AMBER - AMBER TEMPERED GLASS LENS 2"OD X 0.125" ± 0.03"TH	\$20.90
FA1133RED - RED TEMPERED GLASS LENS 2"OD X 0.125" ± 0.03"TH	\$20.90
FA1133BLUE - BLUE TEMPERED GLASS LENS 2"OD X 0.125" ± 0.03"TH	\$20.90
FA1133GREEN - GREEN TEMPERED GLASS LENS 2"OD X 0.125" ± 0.03"TH	\$20.90

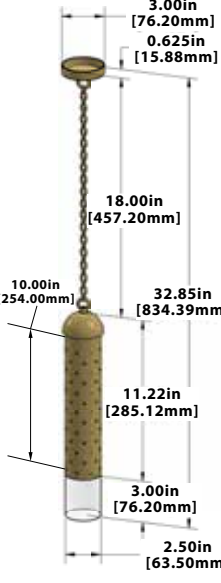

Pendent Lighting



TO PLACE ORDERS
 ORDERS@FOCUSINDUSTRIES.COM
 TOLL FREE (888)882.1350

MORE INFORMATION ON FOCUS PRODUCTS
 DOWNLOAD OUR BROCHURES
 WWW.FOCUSINDUSTRIES.COM

*Prices subject to change. Consult factory for pricing, questions or inquiries.

12V							CURRENT LIST PRICE USD\$	
SL15PS2COP	PENDENT	MATERIAL	FINISH	LED	CCT/LM	SOCKET		
		2.5" DIA X 4" COPPER CYLINDER "STARLIGHT" PENDENT WITH 3" FROSTED ACRYLIC ACCENT, 2.65" CANOPY, 12" STEM (SHOWN)						
	SL15PS2L12COP	COPPER	UNFINISHED	3W OMNI SS LED	3000K/300LM	BA15S	\$203.50	
		2.5" DIA X 4" COPPER CYLINDER "STARLIGHT" PENDENT WITH 3" FROSTED ACRYLIC ACCENT, 4.5" FLAT PLATE, 12" STEM						
	SL15PFPS2L12COP	COPPER	UNFINISHED	3W OMNI SS LED	3000K/300LM	BA15S	\$225.50	
		2.5" DIA X 4" COPPER CYLINDER "STARLIGHT" PENDENT WITH 3" FROSTED ACRYLIC ACCENT, 4.5" CANOPY, 12" STEM						
	SL15P24S2L12COP	COPPER	UNFINISHED	3W OMNI SS LED	3000K/300LM	BA15S	\$231.00	
		FINISHES: (SEE PAGE 49 FOR MORE INFORMATION)						
		ADD ON COST FOR OPTIONAL FINISHES						\$22.00
		ADD ON COST FOR PREMIUM COLOR BKM						\$39.60
		ADD ON COST FOR PREMIUM COLOR DBZ						\$35.20
		ADD ON COST FOR ACID TREATMENT OF COPPER						\$66.00
		*NOTE: CUSTOM PRODUCT CONFIGURATIONS, PAINT FINISHES, AND ACID TREATMENTS ARE AVAILABLE; BUT NON RETURNABLE						
		COLOR GLASS LENS OPTIONS:						
		FA1133AMBER - AMBER TEMPERED GLASS LENS 2"OD X 0.125" ± 0.03"TH						\$20.90
		FA1133RED - RED TEMPERED GLASS LENS 2"OD X 0.125" ± 0.03"TH						\$20.90
		FA1133BLUE - BLUE TEMPERED GLASS LENS 2"OD X 0.125" ± 0.03"TH						\$20.90
		FA1133GREEN - GREEN TEMPERED GLASS LENS 2"OD X 0.125" ± 0.03"TH						\$20.90

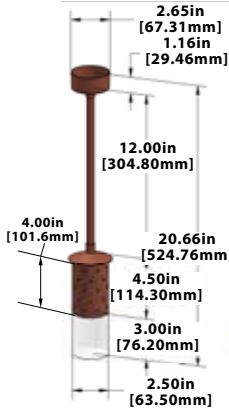

12V							CURRENT LIST PRICE USD\$	
SL15PS2BRS	PENDENT	MATERIAL	FINISH	LED	CCT/LM	SOCKET		
		2.5" DIA X 4" BRASS CYLINDER "STARLIGHT" PENDENT WITH 3" FROSTED ACRYLIC ACCENT, 3" CANOPY, 12" STEM (SHOWN)						
	SL15PS2L12BRS	BRASS	UNFINISHED	3W OMNI SS LED	3000K/300LM	BA15S	\$237.60	
		2.5" DIA X 4" BRASS CYLINDER "STARLIGHT" PENDENT WITH 3" FROSTED ACRYLIC ACCENT, 4.5" FLAT PLATE, 12" STEM						
	SL15PFPS2L12BRS	BRASS	UNFINISHED	3W OMNI SS LED	3000K/300LM	BA15S	\$264.00	
		2.5" DIA X 4" BRASS CYLINDER "STARLIGHT" PENDENT WITH 3" FROSTED ACRYLIC ACCENT, 4.5" CANOPY, 12" STEM						
	SL15P24S2L12BRS	BRASS	UNFINISHED	3W OMNI SS LED	3000K/300LM	BA15S	\$286.00	
		FINISHES: (SEE PAGE 49 FOR MORE INFORMATION)						
		ADD ON COST FOR OPTIONAL FINISHES						\$22.00
		ADD ON COST FOR PREMIUM COLOR BKM						\$39.60
		ADD ON COST FOR PREMIUM COLOR DBZ						\$35.20
		ADD ON COST FOR ACID TREATMENT OF BRASS						\$66.00
		*NOTE: CUSTOM PRODUCT CONFIGURATIONS, PAINT FINISHES, AND ACID TREATMENTS ARE AVAILABLE; BUT NON RETURNABLE						
		COLOR GLASS LENS OPTIONS:						
		FA1133AMBER - AMBER TEMPERED GLASS LENS 2"OD X 0.125" ± 0.03"TH						\$20.90
		FA1133RED - RED TEMPERED GLASS LENS 2"OD X 0.125" ± 0.03"TH						\$20.90
		FA1133BLUE - BLUE TEMPERED GLASS LENS 2"OD X 0.125" ± 0.03"TH						\$20.90
		FA1133GREEN - GREEN TEMPERED GLASS LENS 2"OD X 0.125" ± 0.03"TH						\$20.90

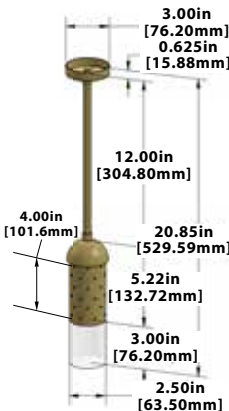

12V-277V									CURRENT LIST PRICE USD\$
----------	--	--	--	--	--	--	--	--	--------------------------

SL1510PS2COP	PENDENT	MATERIAL	FINISH	LED	CCT/LM	SOCKET			
2.5" DIA X 10" COPPER CYLINDER "STARLIGHT" PENDENT WITH 3" FROSTED ACRYLIC ACCENT, 2.65" CANOPY, 12" STEM									
SL1510PS2L24COP		COPPER	UNFINISHED	3W MR16 SS LED 36°	3000K/270LM	GU5.3	12V		\$299.20
2.5" DIA X 10" COPPER CYLINDER STARLIGHT PENDENT WITH 3" FROSTED ACRYLIC ACCENT, 4.5" FLAT PLATE, 12" STEM									
SL1510PFPS2L24COP		COPPER	UNFINISHED	3W MR16 SS LED 36°	3000K/270LM	GU5.3	12V		\$308.00
SL1510PFPS2L108COP		COPPER	UNFINISHED	3W MR16 SS LED 36°	3000K/270LM	GU10	120V		\$322.30
2.5" DIA X 10" COPPER CYLINDER STARLIGHT PENDENT WITH 3" FROSTED ACRYLIC ACCENT, 4.5" CANOPY, 12" STEM									
SL1510P24S2L24COP		COPPER	UNFINISHED	3W MR16 SS LED 36°	3000K/270LM	GU5.3	12V		\$313.50
SL1510P24S2L108COP		COPPER	UNFINISHED	3W MR16 SS LED 36°	3000K/270LM	GU10	120V		\$327.80

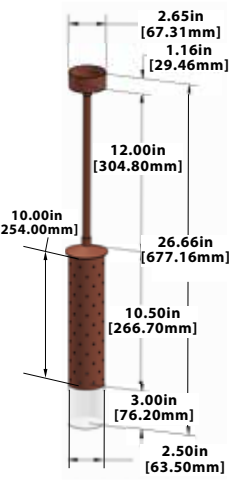

FINISHES: (SEE PAGE 49 FOR MORE INFORMATION)

ADD ON COST FOR OPTIONAL FINISHES	\$22.00
ADD ON COST FOR PREMIUM COLOR BKM	\$29.60
ADD ON COST FOR PREMIUM COLOR DBZ	\$35.20
ADD ON COST FOR ACID TREATMENT OF COPPER	\$66.00

COLOR GLASS LENS OPTIONS:

FA1133AMBE - AMBER TEMPERED GLASS LENS 2"OD X 0.125" ± 0.03"TH	\$20.90
FA1133RED - RED TEMPERED GLASS LENS 2"OD X 0.125" ± 0.03"TH	\$20.90
FA1133BLUE - BLUE TEMPERED GLASS LENS 2"OD X 0.125" ± 0.03"TH	\$20.90
FA1133GREEN - GREEN TEMPERED GLASS LENS 2"OD X 0.125" ± 0.03"TH	\$20.90

CHANGE TO GU10 SOCKET: (SEE PAGE 51 FOR MORE INFORMATION)

FOR LAMPS: L106, L108, L110, L114, L116, L118, L124, L128	\$14.30
---	---------

POWER SUPPLY:

120V-277V USES P/N HW1260LED277R1 TRANSFORMER INSTALLED IN WEATHERPROOF JUNCTION BOX NO MORE THAN 18' FROM FIXTURE	\$99.00
--	---------



12V-277V									CURRENT LIST PRICE USD\$
----------	--	--	--	--	--	--	--	--	--------------------------

SL1510PS2BRS	PENDENT	MATERIAL	FINISH	LED	CCT/LM	SOCKET			
2.5" DIA X 10" BRASS CYLINDER "STARLIGHT" PENDENT WITH 3" FROSTED ACRYLIC ACCENT, 3" CANOPY, 12" STEM									
SL1510PS2L24BRS		BRASS	UNFINISHED	3W MR16 SS LED 36°	3000K/270LM	GU5.3	12V		\$346.50
2.5" DIA X 10" BRASS CYLINDER "STARLIGHT" PENDENT WITH 3" FROSTED ACRYLIC ACCENT, 4.5" FLAT PLATE, 12" STEM									
SL1510PFPS2L24BRS		BRASS	UNFINISHED	3W MR16 SS LED 36°	3000K/270LM	GU5.3	12V		\$341.00
SL1510PFPS2L108BRS		BRASS	UNFINISHED	3W MR16 SS LED 36°	3000K/270LM	GU10	120V		\$355.30

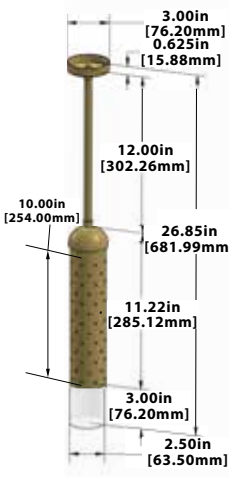

2.5" DIA X 10" BRASS CYLINDER "STARLIGHT" PENDENT WITH 3" FROSTED ACRYLIC ACCENT, 4.5" CANOPY, 12" STEM

SL1510P24S2L24BRS		BRASS	UNFINISHED	3W MR16 SS LED 36°	3000K/270LM	GU5.3	12V		\$368.50
SL1510P24S2L108BRS		BRASS	UNFINISHED	3W MR16 SS LED 36°	3000K/270LM	GU10	120V		\$382.80

FINISHES: (SEE PAGE 49 FOR MORE INFORMATION)

ADD ON COST FOR OPTIONAL FINISHES	\$22.00
ADD ON COST FOR PREMIUM COLOR BKM	\$39.60
ADD ON COST FOR PREMIUM COLOR DBZ	\$35.20
ADD ON COST FOR ACID TREATMENT OF BRASS	\$66.00

COLOR GLASS LENS OPTIONS:

FA1133AMBER - AMBER TEMPERED GLASS LENS 2"OD X 0.125" ± 0.03"TH	\$20.90
FA1133RED - RED TEMPERED GLASS LENS 2"OD X 0.125" ± 0.03"TH	\$20.90
FA1133BLUE - BLUE TEMPERED GLASS LENS 2"OD X 0.125" ± 0.03"TH	\$20.90
FA1133GREEN - GREEN TEMPERED GLASS LENS 2"OD X 0.125" ± 0.03"TH	\$20.90

CHANGE TO GU10 SOCKET: (SEE PAGE 51 FOR MORE INFORMATION)

FOR LAMPS: L106, L108, L110, L114, L116, L118, L124, L128	\$14.30
---	---------

POWER SUPPLY:

120V-277V USES P/N HW1260LED277R1 TRANSFORMER INSTALLED IN WEATHERPROOF JUNCTION BOX NO MORE THAN 18' FROM FIXTURE	\$99.00
--	---------

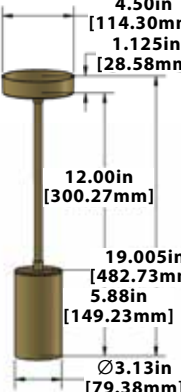

120V-277V RXS10PBRS	PENDENT	MATERIAL	FINISH	LED	CCT/LM	SOCKET	CURRENT LIST PRICE USD\$
	3.13" DIA X 5.88" BRASS CYLINDER PENDENT, 4.5" CANOPY, 12" STEM						
	RXS10P24L140BRS	BRASS	UNFINISHED	8W PAR20 LED 15°	3000K/720LM	MEDIUM BASE	\$328.90
	FINISHES: (SEE PAGE 49 FOR MORE INFORMATION)						
	ADD ON COST FOR OPTIONAL FINISHES						\$22.00
	ADD ON COST FOR PREMIUM COLOR BKM						\$39.60
	ADD ON COST FOR PREMIUM COLOR DBZ						\$35.20
	ADD ON COST FOR ACID TREATMENT OF BRASS						\$66.00
	*NOTE: CUSTOM PRODUCT CONFIGURATIONS, PAINT FINISHES, AND ACID TREATMENTS ARE AVAILABLE; BUT NON RETURNABLE						
	COLOR GLASS LENS OPTIONS:						
	FA1020AMBER - AMBER TEMPERED GLASS LENS 2.9"OD X 0.125"						\$23.00
	FA1020RED - RED TEMPERED GLASS LENS 2.9"OD X 0.125"						\$23.00
	FA1020BLUE - BLUE TEMPERED GLASS LENS 2.9"OD X 0.125"						\$23.00
	FA1020GREEN - GREEN TEMPERED GLASS LENS 2.9"OD X 0.125"						\$23.00

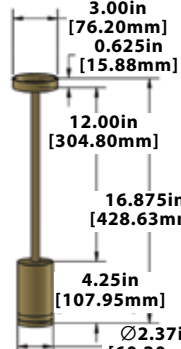
12V RXS12PBRS	PENDENT	MATERIAL	FINISH	LED	CCT/LM	SOCKET	CURRENT LIST PRICE USD\$
	2.37" DIA X 4.25" BRASS CYLINDER PENDENT, 3" CANOPY, 12" STEM						
	RXS12PL24BRS	BRASS	UNFINISHED	3W MR16 LED 36°	3000K/270LM	GU5.3	\$181.50
	FINISHES: (SEE PAGE 49 FOR MORE INFORMATION)						
	ADD ON COST FOR OPTIONAL FINISHES						\$22.00
	ADD ON COST FOR PREMIUM COLOR BKM						\$39.60
	ADD ON COST FOR PREMIUM COLOR DBZ						\$35.20
	ADD ON COST FOR ACID TREATMENT OF BRASS						\$66.00
	*NOTE: CUSTOM PRODUCT CONFIGURATIONS, PAINT FINISHES, AND ACID TREATMENTS ARE AVAILABLE; BUT NON RETURNABLE						
	COLOR GLASS LENS OPTIONS:						
	FA1133AMBER - AMBER TEMPERED GLASS LENS 2"OD X 0.125" ± 0.03"TH						\$20.90
	FA1133RED - RED TEMPERED GLASS LENS 2"OD X 0.125" ± 0.03"TH						\$20.90
	FA1133BLUE - BLUE TEMPERED GLASS LENS 2"OD X 0.125" ± 0.03"TH						\$20.90
	FA1133GREEN - GREEN TEMPERED GLASS LENS 2"OD X 0.125" ± 0.03"TH						\$20.90

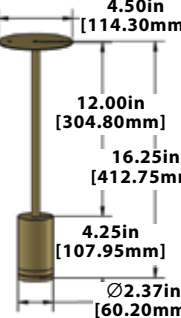
12V-277V RXS12PFBRBS	PENDENT	MATERIAL	FINISH	LED	CCT/LM	SOCKET	CURRENT LIST PRICE USD\$
	2.37" DIA X 4.25" BRASS CYLINDER PENDENT, 4.5" FLAT PLATE, 12" STEM						
	RXS12PFPL24BRS	BRASS	UNFINISHED	3W MR16 LED 36°	3000K/270LM	GU5.3 12V	\$203.50
	RXS12PFPL108BRS	BRASS	UNFINISHED	3W MR16 LED 36°	3000K/270LM	GU10 120V	\$217.80
	FINISHES: (SEE PAGE 49 FOR MORE INFORMATION)						
	ADD ON COST FOR OPTIONAL FINISHES						\$22.00
	ADD ON COST FOR PREMIUM COLOR BKM						\$39.60
	ADD ON COST FOR PREMIUM COLOR DBZ						\$35.20
	ADD ON COST FOR ACID TREATMENT OF BRASS						\$66.00
	*NOTE: CUSTOM PRODUCT CONFIGURATIONS, PAINT FINISHES, AND ACID TREATMENTS ARE AVAILABLE; BUT NON RETURNABLE						
	COLOR GLASS LENS OPTIONS:						
	FA1133AMBER - AMBER TEMPERED GLASS LENS 2"OD X 0.125" ± 0.03"TH						\$20.90
	FA1133RED - RED TEMPERED GLASS LENS 2"OD X 0.125" ± 0.03"TH						\$20.90
	FA1133BLUE - BLUE TEMPERED GLASS LENS 2"OD X 0.125" ± 0.03"TH						\$20.90
	FA1133GREEN - GREEN TEMPERED GLASS LENS 2"OD X 0.125" ± 0.03"TH						\$20.90



POWER SUPPLY:	CURRENT LIST PRICE USD\$
120V-277V USES P/N HW1260LED277R1 TRANSFORMER INSTALLED IN WEATHERPROOF JUNCTION BOX NO MORE THAN 18' FROM FIXTURE	\$99.00

12V-277V RXS12P24BRS	PENDENT	MATERIAL	FINISH	LED	CCT/LM	SOCKET	CURRENT LIST PRICE USD\$
-------------------------	---------	----------	--------	-----	--------	--------	-----------------------------

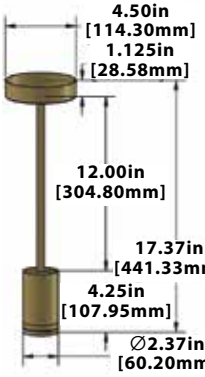

2.37" DIA X 4.25" BRASS CYLINDER PENDENT, 4.5" CANOPY, 12" STEM

RXS12P24L24BRS	BRASS	UNFINISHED	3W MR16 LED 36°	3000K/270LM	GU5.3	12V	\$231.00
RXS12P24L108BRS	BRASS	UNFINISHED	3W MR16 LED 36°	3000K/270LM	GU10	120V	\$245.30

FINISHES: (SEE PAGE 49 FOR MORE INFORMATION)

ADD ON COST FOR OPTIONAL FINISHES	\$22.00
ADD ON COST FOR PREMIUM COLOR BKM	\$39.60
ADD ON COST FOR PREMIUM COLOR DBZ	\$35.20
ADD ON COST FOR ACID TREATMENT OF BRASS	\$66.00

*NOTE: CUSTOM PRODUCT CONFIGURATIONS, PAINT FINISHES, AND ACID TREATMENTS ARE AVAILABLE; BUT NON RETURNABLE

COLOR GLASS LENS OPTIONS:

FA1133AMBER - AMBER TEMPERED GLASS LENS 2"OD X 0.125" ± 0.03"TH	\$20.90
FA1133RED - RED TEMPERED GLASS LENS 2"OD X 0.125" ± 0.03"TH	\$20.90
FA1133BLUE - BLUE TEMPERED GLASS LENS 2"OD X 0.125" ± 0.03"TH	\$20.90
FA1133GREEN - GREEN TEMPERED GLASS LENS 2"OD X 0.125" ± 0.03"TH	\$20.90



POWER SUPPLY:

120V-277V USES P/N HW1260LED277R1 TRANSFORMER INSTALLED IN WEATHERPROOF JUNCTION BOX NO MORE THAN 18' FROM FIXTURE	\$99.00
--	---------

12V RXS13PBRS	PENDENT	MATERIAL	FINISH	LED	CCT/LM	SOCKET	CURRENT LIST PRICE USD\$
------------------	---------	----------	--------	-----	--------	--------	-----------------------------

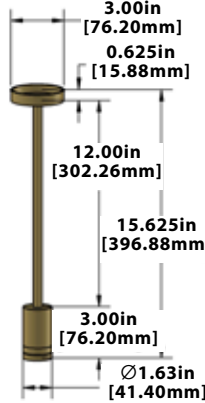

1.63" DIA X 3.00" BRASS CYLINDER PENDENT, 3" CANOPY, 12" STEM (SHOWN)

RXS13P24L68BRS	BRASS	UNFINISHED	3W MR11 LED 40°	3000K/300LM	GU4		\$190.00
RXS13PFPL68BRS	BRASS	UNFINISHED	3W MR11 LED 40°	3000K/300LM	GU4		\$176.00
RXS13PL68BRS	BRASS	UNFINISHED	3W MR11 LED 40°	3000K/300LM	GU4		\$156.00

FINISHES: (SEE PAGE 49 FOR MORE INFORMATION)

ADD ON COST FOR OPTIONAL FINISHES	\$22.00
ADD ON COST FOR PREMIUM COLOR BKM	\$39.60
ADD ON COST FOR PREMIUM COLOR DBZ	\$35.20
ADD ON COST FOR ACID TREATMENT OF BRASS	\$66.00

*NOTE: CUSTOM PRODUCT CONFIGURATIONS, PAINT FINISHES, AND ACID TREATMENTS ARE AVAILABLE; BUT NON RETURNABLE

12V-277V RXS18PBRS	PENDENT	MATERIAL	FINISH	LED	CCT/LM	SOCKET	CURRENT LIST PRICE USD\$
-----------------------	---------	----------	--------	-----	--------	--------	-----------------------------

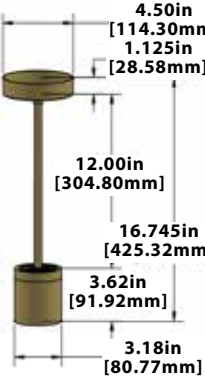

3.18" DIA X 3.62" BRASS CYLINDER PENDENT, 4.5" CANOPY, 12" STEM

RXS18P24LEDM715BRS	BRASS	UNFINISHED	7W LED MODULE 15°	2800K/550LM	NONE		\$374.00
RXS18P24LEDM740BRS	BRASS	UNFINISHED	7W LED MODULE 40°	2800K/550LM	NONE		\$374.00
RXS18P24LEDM760BRS	BRASS	UNFINISHED	7W LED MODULE 60°	2800K/550LM	NONE		\$374.00
RXS18P24LEDM7WFBRS	BRASS	UNFINISHED	WIDE FLOOD 160°	2800K/550LM	NONE		\$352.00

FINISHES: (SEE PAGE 49 FOR MORE INFORMATION)

ADD ON COST FOR OPTIONAL FINISHES	\$22.00
ADD ON COST FOR PREMIUM COLOR BKM	\$39.60
ADD ON COST FOR PREMIUM COLOR DBZ	\$35.20
ADD ON COST FOR ACID TREATMENT OF BRASS	\$66.00

*NOTE: CUSTOM PRODUCT CONFIGURATIONS, PAINT FINISHES, AND ACID TREATMENTS ARE AVAILABLE; BUT NON RETURNABLE

COLOR GLASS LENS OPTIONS:

FA1020AMBER - AMBER TEMPERED GLASS LENS 2.9"OD X 0.125"	\$19.80
FA1020RED - RED TEMPERED GLASS LENS 2.9"OD X 0.125"	\$19.80
FA1020BLUE - BLUE TEMPERED GLASS LENS 2.9"OD X 0.125"	\$19.80
FA1020GREEN - GREEN TEMPERED GLASS LENS 2.9"OD X 0.125"	\$19.80



POWER SUPPLY:

120V-277V USES P/N HW1260LED277R1 TRANSFORMER INSTALLED IN WEATHERPROOF JUNCTION BOX NO MORE THAN 18' FROM FIXTURE	\$99.00
--	---------

120V-277V RXS10PCOP	PENDENT	MATERIAL	FINISH	LED	CCT/LM	SOCKET	CURRENT LIST PRICE USD\$
------------------------	---------	----------	--------	-----	--------	--------	-----------------------------

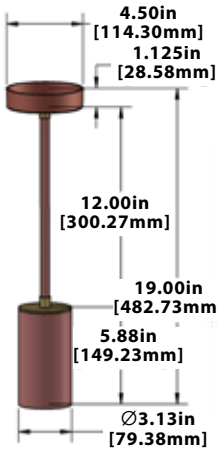

3.13" DIA X 5.88" COPPER CYLINDER PENDENT, 4.5" COPPER CANOPY, 12" STEM							
RXS10P24L140COP	COPPER	UNFINISHED	8W PAR20 LED 15°	3000K/720LM	MEDIUM BASE		\$328.90

FINISHES: (SEE PAGE 49 FOR MORE INFORMATION)							
ADD ON COST FOR OPTIONAL FINISHES							\$22.00
ADD ON COST FOR PREMIUM COLOR BKM							\$39.60
ADD ON COST FOR PREMIUM COLOR DBZ							\$35.20
ADD ON COST FOR ACID TREATMENT OF COPPER							\$66.00

*NOTE: CUSTOM PRODUCT CONFIGURATIONS, PAINT FINISHES, AND ACID TREATMENTS ARE AVAILABLE; BUT NON RETURNABLE

COLOR GLASS LENS OPTIONS:							
FA1133AMBER - AMBER TEMPERED GLASS LENS 2.9"OD X 0.125" ± 0.03"TH							\$23.00
FA1133RED - RED TEMPERED GLASS LENS 2.9"OD X 0.125" ± 0.03"TH							\$23.00
FA1133BLUE - BLUE TEMPERED GLASS LENS 2.9"OD X 0.125" ± 0.03"TH							\$23.00
FA1133GREEN - GREEN TEMPERED GLASS LENS 2.9"OD X 0.125" ± 0.03"TH							\$23.00

12V-277V RXS12PFPCOP	PENDENT	MATERIAL	FINISH	LED	CCT/LM	SOCKET	CURRENT LIST PRICE USD\$
-------------------------	---------	----------	--------	-----	--------	--------	-----------------------------

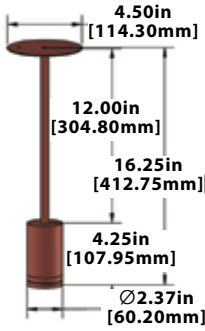

2.37" DIA X 4.25" COPPER CYLINDER PENDENT, 4.5" FLAT PLATE, 12" STEM							
RXS12PFPL24COP	COPPER	UNFINISHED	3W MR16 LED 36°	3000K/270LM	GU5.3	12V	\$204.60
RXS12PFPL108COP	COPPER	UNFINISHED	3W MR16 LED 36°	3000K/270LM	GU10	120V	\$218.90

FINISHES: (SEE PAGE 49 FOR MORE INFORMATION)							
ADD ON COST FOR OPTIONAL FINISHES							\$22.00
ADD ON COST FOR PREMIUM COLOR BKM							\$39.60
ADD ON COST FOR PREMIUM COLOR DBZ							\$35.20
ADD ON COST FOR ACID TREATMENT OF COPPER							\$66.00

*NOTE: CUSTOM PRODUCT CONFIGURATIONS, PAINT FINISHES, AND ACID TREATMENTS ARE AVAILABLE; BUT NON RETURNABLE

COLOR GLASS LENS OPTIONS:							
FA1020AMBER - AMBER TEMPERED GLASS LENS 2"OD X 0.125"							\$20.90
FA1020RED - RED TEMPERED GLASS LENS 2"OD X 0.125"							\$20.90
FA1020BLUE - BLUE TEMPERED GLASS LENS 2"OD X 0.125"							\$20.90
FA1020GREEN - GREEN TEMPERED GLASS LENS 2"OD X 0.125"							\$20.90



POWER SUPPLY:							
120V-277V USES P/N HW1260LED277R1 TRANSFORMER INSTALLED IN WEATHERPROOF JUNCTION BOX NO MORE THAN 18' FROM FIXTURE							\$99.00

12V-277V RXS12P24COP	PENDENT	MATERIAL	FINISH	LED	CCT/LM	SOCKET	CURRENT LIST PRICE USD\$
-------------------------	---------	----------	--------	-----	--------	--------	-----------------------------



2.37" DIA X 4.25" COPPER CYLINDER PENDENT, 4.5" COPPER CANOPY, 12" STEM							
RXS12P24L24COP	COPPER	UNFINISHED	3W MR16 LED 36°	3000K/270LM	GU5.3	12V	\$245.30
RXS12P24L108COP	COPPER	UNFINISHED	3W MR16 LED 36°	3000K/270LM	GU10	120V	\$259.60

FINISHES: (SEE PAGE 49 FOR MORE INFORMATION)							
ADD ON COST FOR OPTIONAL FINISHES							\$22.00
ADD ON COST FOR PREMIUM COLOR BKM							\$39.60
ADD ON COST FOR PREMIUM COLOR DBZ							\$35.20
ADD ON COST FOR ACID TREATMENT OF COPPER							\$66.00

*NOTE: CUSTOM PRODUCT CONFIGURATIONS, PAINT FINISHES, AND ACID TREATMENTS ARE AVAILABLE; BUT NON RETURNABLE

COLOR GLASS LENS OPTIONS:							
FA1020AMBER - AMBER TEMPERED GLASS LENS 2"OD X 0.125"							\$20.90
FA1020RED - RED TEMPERED GLASS LENS 2"OD X 0.125"							\$20.90
FA1020BLUE - BLUE TEMPERED GLASS LENS 2"OD X 0.125"							\$20.90
FA1020GREEN - GREEN TEMPERED GLASS LENS 2"OD X 0.125"							\$20.90



POWER SUPPLY:							
120V-277V USES P/N HW1260LED277R1 TRANSFORMER INSTALLED IN WEATHERPROOF JUNCTION BOX NO MORE THAN 18' FROM FIXTURE							\$99.00

12V RXS13PCOP	PENDENT	MATERIAL	FINISH	LED	CCT/LM	SOCKET	CURRENT LIST PRICE USD\$
------------------	---------	----------	--------	-----	--------	--------	-----------------------------

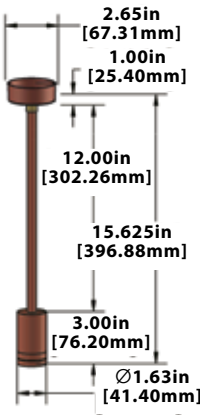

1.63" DIA X 3.00" COPPER CYLINDER PENDENT, 3" CANOPY, 12" STEM

RXS13P24L68COP	COPPER	UNFINISHED	3W MR11 LED 40°	3000K/300LM	GU4	\$190.00
RXS13PFPL68COP	COPPER	UNFINISHED	3W MR11 LED 40°	3000K/300LM	GU4	\$176.00
RXS13PL68COP	COPPER	UNFINISHED	3W MR11 LED 40°	3000K/300LM	GU4	\$156.00

FINISHES: (SEE PAGE 49 FOR MORE INFORMATION)

ADD ON COST FOR OPTIONAL FINISHES	\$22.00
ADD ON COST FOR PREMIUM COLOR BKM	\$39.60
ADD ON COST FOR PREMIUM COLOR DBZ	\$35.20
ADD ON COST FOR ACID TREATMENT OF COPPER	\$66.00

*NOTE: CUSTOM PRODUCT CONFIGURATIONS, PAINT FINISHES, AND ACID TREATMENTS ARE AVAILABLE; BUT NON RETURNABLE

12V-277V RXS18PCOP	PENDENT	MATERIAL	FINISH	LED	CCT/LM	SOCKET	CURRENT LIST PRICE USD\$
-----------------------	---------	----------	--------	-----	--------	--------	-----------------------------

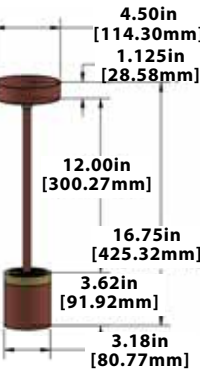

3.18" DIA X 3.62" COPPER CYLINDER PENDENT, 4.5" CANOPY, 12" STEM

RXS18P24LED715COP	COPPER	UNFINISHED	7W LED MODULE 15°	2800K/550LM	NONE	\$386.10
RXS18P24LED740COP	COPPER	UNFINISHED	7W LED MODULE 40°	2800K/550LM	NONE	\$386.10
RXS18P24LED760COP	COPPER	UNFINISHED	7W LED MODULE 60°	2800K/550LM	NONE	\$386.10
RXS18P24LED7WFCOP	COPPER	UNFINISHED	WIDE FLOOD 160°	2800K/550LM	NONE	\$364.10

FINISHES: (SEE PAGE 49 FOR MORE INFORMATION)

ADD ON COST FOR OPTIONAL FINISHES	\$22.00
ADD ON COST FOR PREMIUM COLOR BKM	\$39.60
ADD ON COST FOR PREMIUM COLOR DBZ	\$35.20
ADD ON COST FOR ACID TREATMENT OF COPPER	\$66.00

*NOTE: CUSTOM PRODUCT CONFIGURATIONS, PAINT FINISHES, AND ACID TREATMENTS ARE AVAILABLE; BUT NON RETURNABLE

COLOR GLASS LENS OPTIONS:

FA1020AMBER - AMBER TEMPERED GLASS LENS 2.9"OD X 0.125" ± 0.03"TH	\$23.00
FA1020RED - RED TEMPERED GLASS LENS 2.9"OD X 0.125" ± 0.03"TH	\$23.00
FA1020BLUE - BLUE TEMPERED GLASS LENS 2.9"OD X 0.125" ± 0.03"TH	\$23.00
FA1020GREEN - GREEN TEMPERED GLASS LENS 2.9"OD X 0.125" ± 0.03"TH	\$23.00



POWER SUPPLY:

120V-277V USES P/N HW1260LED277R1 TRANSFORMER INSTALLED IN WEATHERPROOF JUNCTION BOX NO MORE THAN 18' FROM FIXTURE	\$99.00
--	---------

12V-277V RXS12PSS	PENDENT	MATERIAL	FINISH	LED	CCT/LM	SOCKET	CURRENT LIST PRICE USD\$
----------------------	---------	----------	--------	-----	--------	--------	--------------------------

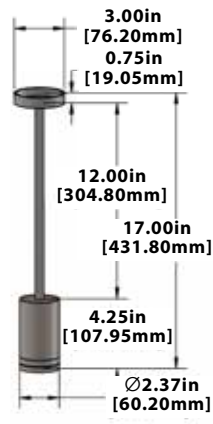

2.37" DIA X 4.25" STAINLESS STEEL CYLINDER PENDENT, 3" CANOPY, 12" STEM							
RXS12PL24SS	STAINLESS STEEL	UNFINISHED	3W MR16 LED 36°	3000K/270LM	GU5.3	12V	\$262.50

FINISHES: (SEE PAGE 49 FOR MORE INFORMATION)							
ADD ON COST FOR OPTIONAL FINISHES							\$22.00
ADD ON COST FOR PREMIUM COLOR BKM							\$39.60
ADD ON COST FOR PREMIUM COLOR DBZ							\$35.20
ADD ON COST FOR ACID TREATMENT OF STAINLESS STEEL							\$66.00

*NOTE: CUSTOM PRODUCT CONFIGURATIONS, PAINT FINISHES, AND ACID TREATMENTS ARE AVAILABLE; BUT NON RETURNABLE

COLOR GLASS LENS OPTIONS:							
FA1133AMBER - AMBER TEMPERED GLASS LENS 2"OD X 0.125" ± 0.03"TH							\$20.90
FA1133RED - RED TEMPERED GLASS LENS 2"OD X 0.125" ± 0.03"TH							\$20.90
FA1133BLUE - BLUE TEMPERED GLASS LENS 2"OD X 0.125" ± 0.03"TH							\$20.90
FA1133GREEN - GREEN TEMPERED GLASS LENS 2"OD X 0.125" ± 0.03"TH							\$20.90

POWER SUPPLY:							
120V-277V USES P/N HW1260LED277R1 TRANSFORMER INSTALLED IN WEATHERPROOF JUNCTION BOX NO MORE THAN 18' FROM FIXTURE							\$99.00



12V-277V RXS12PFPSS	PENDENT	MATERIAL	FINISH	LED	CCT/LM	SOCKET	CURRENT LIST PRICE USD\$
------------------------	---------	----------	--------	-----	--------	--------	--------------------------

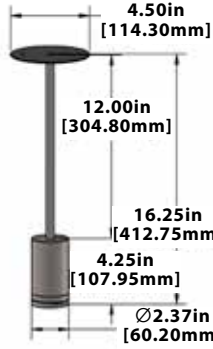

2.37" DIA X 4.25" STAINLESS STEEL CYLINDER PENDENT, 4.5" FLAT PLATE, 12" STEM							
RXS12PFPL24SS	STAINLESS STEEL	UNFINISHED	3W MR16 LED 36°	3000K/270LM	GU5.3	12V	\$256.25
RXS12PFPL108SS	STAINLESS STEEL	UNFINISHED	3W MR16 LED 36°	3000K/270LM	GU10	120V	\$270.55

FINISHES: (SEE PAGE 49 FOR MORE INFORMATION)							
ADD ON COST FOR OPTIONAL FINISHES							\$22.00
ADD ON COST FOR PREMIUM COLOR BKM							\$39.60
ADD ON COST FOR PREMIUM COLOR DBZ							\$35.20
ADD ON COST FOR ACID TREATMENT OF STAINLESS STEEL							\$66.00

*NOTE: CUSTOM PRODUCT CONFIGURATIONS, PAINT FINISHES, AND ACID TREATMENTS ARE AVAILABLE; BUT NON RETURNABLE

COLOR GLASS LENS OPTIONS:							
FA1133AMBER - AMBER TEMPERED GLASS LENS 2"OD X 0.125" ± 0.03"TH							\$20.90
FA1133RED - RED TEMPERED GLASS LENS 2"OD X 0.125" ± 0.03"TH							\$20.90
FA1133BLUE - BLUE TEMPERED GLASS LENS 2"OD X 0.125" ± 0.03"TH							\$20.90
FA1133GREEN - GREEN TEMPERED GLASS LENS 2"OD X 0.125" ± 0.03"TH							\$20.90

POWER SUPPLY:							
120V-277V USES P/N HW1260LED277R1 TRANSFORMER INSTALLED IN WEATHERPROOF JUNCTION BOX NO MORE THAN 18' FROM FIXTURE							\$99.00



12V-277V RXS12P24SS	PENDENT	MATERIAL	FINISH	LED	CCT/LM	SOCKET	CURRENT LIST PRICE USD\$
------------------------	---------	----------	--------	-----	--------	--------	--------------------------

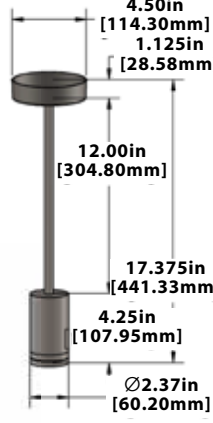

2.37" DIA X 4.25" STAINLESS STEEL CYLINDER PENDENT, 4.5" CANOPY, 12" STEM							
RXS12P24L24SS	STAINLESS STEEL	UNFINISHED	3W MR16 LED 36°	3000K/270LM	GU5.3	12V	\$300.00
RXS12P24L108SS	STAINLESS STEEL	UNFINISHED	3W MR16 LED 36°	3000K/270LM	GU10	120V	\$314.30

FINISHES: (SEE PAGE 49 FOR MORE INFORMATION)							
ADD ON COST FOR OPTIONAL FINISHES							\$22.00
ADD ON COST FOR PREMIUM COLOR BKM							\$39.60
ADD ON COST FOR PREMIUM COLOR DBZ							\$35.20
ADD ON COST FOR ACID TREATMENT OF STAINLESS STEEL							\$66.00

*NOTE: CUSTOM PRODUCT CONFIGURATIONS, PAINT FINISHES, AND ACID TREATMENTS ARE AVAILABLE; BUT NON RETURNABLE

COLOR GLASS LENS OPTIONS:							
FA1133AMBER - AMBER TEMPERED GLASS LENS 2"OD X 0.125" ± 0.03"TH							\$20.90
FA1133RED - RED TEMPERED GLASS LENS 2"OD X 0.125" ± 0.03"TH							\$20.90
FA1133BLUE - BLUE TEMPERED GLASS LENS 2"OD X 0.125" ± 0.03"TH							\$20.90
FA1133GREEN - GREEN TEMPERED GLASS LENS 2"OD X 0.125" ± 0.03"TH							\$20.90

POWER SUPPLY:							
120V-277V USES P/N HW1260LED277R1 TRANSFORMER INSTALLED IN WEATHERPROOF JUNCTION BOX NO MORE THAN 18' FROM FIXTURE							\$99.00



Path Lighting

TO PLACE ORDERS
ORDERS@FOCUSINDUSTRIES.COM
TOLL FREE (888)882.1350

MORE INFORMATION ON FOCUS PRODUCTS
DOWNLOAD OUR BROCHURES
WWW.FOCUSINDUSTRIES.COM

*Prices subject to change. Consult factory for pricing, questions or inquiries.

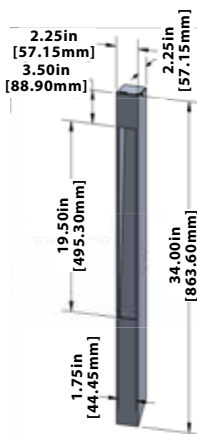
12V-277V PL23	SQUARE BOLLARD	MATERIAL	FINISH	LED	CCT/LM	SOCKET	CURRENT LIST PRICE USD\$	
	28" ALUMINUM OR BRASS ANGLE CUT BOLLARD, FLAT TOP STANDARD							
	PL2328L12BLT	ALUMINUM	UNFINISHED	3W OMNI SS LED	3000K/300LM	BA15S (SINGLE CONTACT)	\$193.60	
	PL2328L12BRS	BRASS	UNFINISHED	3W OMNI SS LED	3000K/300LM	BA15S (SINGLE CONTACT)	\$424.60	
	34" ALUMINUM OR BRASS ANGLE CUT BOLLARD, FLAT TOP STANDARD (SHOWN)							
	PL2334L12BLT	ALUMINUM	UNFINISHED	3W OMNI SS LED	3000K/300LM	BA15S (SINGLE CONTACT)	\$204.60	
	PL2334L12BRS	BRASS	UNFINISHED	3W OMNI SS LED	3000K/300LM	BA15S (SINGLE CONTACT)	\$457.60	
	FINISHES: (SEE PAGE 49 FOR MORE INFORMATION)							
	ADD ON COST FOR OPTIONAL FINISHES							\$11.00
	ADD ON COST FOR PREMIUM COLOR BKM							\$19.80
	ADD ON COST FOR PREMIUM COLOR DBZ							\$17.60
ADD ON COST FOR ACID TREATMENT OF BRASS							\$33.00	
*NOTE: CUSTOM PRODUCT CONFIGURATIONS, PAINT FINISHES, AND ACID TREATMENTS ARE AVAILABLE; BUT NON RETURNABLE								
LEAD WIRE:								
25' 16/2 LEAD WIRE - ADD (25F) TO PART NUMBER (12V ONLY)							\$16.50	
120V OPTION: (SEE PAGE 51 FOR MORE INFORMATION)								
CHANGE TO GU10 SOCKET - FOR LAMPS: L106, L108, L110, L114, L116, L118, L124, L128							\$11.00	
POWER SUPPLY:								
120V-277V USES P/N HW1260LED277R1 TRANSFORMER INSTALLED IN WEATHERPROOF JUNCTION BOX NO MORE THAN 18' FROM FIXTURE							\$99.00	

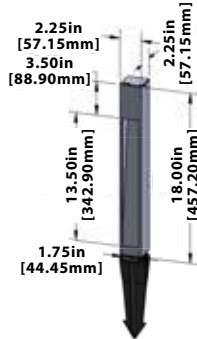

12V-277V PL23	SQUARE BOLLARD	MATERIAL	FINISH	LED	CCT/LM	SOCKET	CURRENT LIST PRICE USD\$	
	18" ALUMINUM OR BRASS DECK MOUNT BOLLARD, FLAT TOP, FA03LG LARGE BLACK ABS STAKE (SHOWN)							
	PL23DM18L12BLT	ALUMINUM	BLACK TEXTURE	3W OMNI SS LED	3000K/300LM	BA15S (SINGLE CONTACT)	\$149.60	
	PL23DM18NLBTL	ALUMINUM	BLACK TEXTURE	NO LAMP		BA15S (SINGLE CONTACT)	\$132.00	
	PL23DM18L12BRS	BRASS	UNFINISHED	3W OMNI SS LED	3000K/300LM	BA15S (SINGLE CONTACT)	\$325.60	
	24" ALUMINUM OR BRASS DECK MOUNT BOLLARD, FLAT TOP, FA03LG LARGE BLACK ABS STAKE							
	PL23DM24L12BLT	ALUMINUM	UNFINISHED	3W OMNI SS LED	3000K/300LM	BA15S (SINGLE CONTACT)	\$160.60	
	PL23DM24NLBTL	ALUMINUM	UNFINISHED	NO LAMP		BA15S (SINGLE CONTACT)	\$143.00	
	PL23DM24L12BRS	BRASS	UNFINISHED	3W OMNI SS LED	3000K/300LM	BA15S (SINGLE CONTACT)	\$380.60	
	FINISHES: (SEE PAGE 49 FOR MORE INFORMATION)							
	ADD ON COST FOR OPTIONAL FINISHES							\$11.00
ADD ON COST FOR PREMIUM COLOR BKM							\$19.80	
ADD ON COST FOR PREMIUM COLOR DBZ							\$17.60	
ADD ON COST FOR ACID TREATMENT OF BRASS							\$33.00	
*NOTE: CUSTOM PRODUCT CONFIGURATIONS, PAINT FINISHES, AND ACID TREATMENTS ARE AVAILABLE; BUT NON RETURNABLE								
LEAD WIRE:								
25' 16/2 LEAD WIRE - ADD (25F) TO PART NUMBER (12V ONLY)							\$16.50	
120V OPTION: (SEE PAGE 51 FOR MORE INFORMATION)								
CHANGE TO GU10 SOCKET - FOR LAMPS: L106, L108, L110, L114, L116, L118, L124, L128							\$11.00	
POWER SUPPLY:								
120V-277V USES P/N HW1260LED277R1 TRANSFORMER INSTALLED IN WEATHERPROOF JUNCTION BOX NO MORE THAN 18' FROM FIXTURE							\$99.00	



12V-277V PL23LEDP	SQUARE BOLLARD	MATERIAL	FINISH	LED	CCT/LM	SOCKET	CURRENT LIST PRICE USD\$
----------------------	----------------	----------	--------	-----	--------	--------	-----------------------------

28" ALUMINUM OR BRASS ANGLE CUT BOLLARD, FLAT TOP							
2.25in [57.15mm]	PL2328LEDPBLT	ALUMINUM	UNFINISHED	4W LED PANEL	3000K/300LM	NONE	\$253.00
3.50in [88.90mm]	PL2328LEDPBRS	BRASS	UNFINISHED	4W LED PANEL	3000K/300LM	NONE	\$462.00

34" ALUMINUM OR BRASS ANGLE CUT BOLLARD, FLAT TOP (SHOWN)							
2.25in [57.15mm]	PL2334LEDPBLT	ALUMINUM	UNFINISHED	4W LED PANEL	3000K/300LM	NONE	\$264.00
3.50in [88.90mm]	PL2334LEDPBRS	BRASS	UNFINISHED	4W LED PANEL	3000K/300LM	NONE	\$517.00

FINISHES: (SEE PAGE 49 FOR MORE INFORMATION)							
19.50in [495.30mm]	ADD ON COST FOR OPTIONAL FINISHES						\$11.00
34.00in [863.60mm]	ADD ON COST FOR PREMIUM COLOR BKM						\$19.80
	ADD ON COST FOR PREMIUM COLOR DBZ						\$17.60
	ADD ON COST FOR ACID TREATMENT OF BRASS						\$33.00

LEAD WIRE:							
1.75in [44.45mm]	25' 16/2 LEAD WIRE - ADD (25F) TO PART NUMBER (12V ONLY)						\$16.50

POWER SUPPLY:							
	120V-277V USES P/N HW1260LED277R1 TRANSFORMER INSTALLED IN WEATHERPROOF JUNCTION BOX NO MORE THAN 18' FROM FIXTURE						\$99.00
*NOTE: ALL LED PANELS INCLUDE AN INTERNAL 12V DRIVER (HW12535012LED)							

12V-277V PL23DMLEDP	SQUARE BOLLARD	MATERIAL	FINISH	LED	CCT/LM	SOCKET	CURRENT LIST PRICE USD\$
------------------------	----------------	----------	--------	-----	--------	--------	-----------------------------

18" ALUMINUM OR BRASS DECK MOUNT BOLLARD, FLAT TOP, FA03LG LARGE BLACK ABS STAKE (SHOWN)							
2.25in [57.15mm]	PL23DM18LEDPBLT	ALUMINUM	BLACK TEXTURE	4W LED PANEL	3000K/300LM	NONE	\$209.00
3.50in [88.90mm]	PL23DM18LEDPBRS	BRASS	UNFINISHED	4W LED PANEL	3000K/300LM	NONE	\$385.60

24" ALUMINUM OR BRASS DECK MOUNT BOLLARD, FLAT TOP, FA03LG LARGE BLACK ABS STAKE							
2.25in [57.15mm]	PL23DM24LEDPBLT	ALUMINUM	UNFINISHED	4W LED PANEL	3000K/300LM	NONE	\$220.00
3.50in [88.90mm]	PL23DM24LEDPBRS	BRASS	UNFINISHED	4W LED PANEL	3000K/300LM	NONE	\$440.00

FINISHES: (SEE PAGE 49 FOR MORE INFORMATION)							
13.50in [342.90mm]	ADD ON COST FOR OPTIONAL FINISHES						\$11.00
18.00in [457.20mm]	ADD ON COST FOR PREMIUM COLOR BKM						\$19.80
	ADD ON COST FOR PREMIUM COLOR DBZ						\$17.60
	ADD ON COST FOR ACID TREATMENT OF BRASS						\$33.00

LEAD WIRE:							
1.75in [44.45mm]	25' 16/2 LEAD WIRE - ADD (25F) TO PART NUMBER (12V ONLY)						\$16.50

POWER SUPPLY:							
	120V-277V USES P/N HW1260LED277R1 TRANSFORMER INSTALLED IN WEATHERPROOF JUNCTION BOX NO MORE THAN 18' FROM FIXTURE						\$99.00
*NOTE: ALL LED PANELS INCLUDE AN INTERNAL 12V DRIVER (HW12535012LED)							



12V-277V	PL23S1/PL23S1LEDP SQUARE BOLLARD	MATERIAL	FINISH	LED	CCT/LM	SOCKET	CURRENT LIST PRICE USD\$
----------	----------------------------------	----------	--------	-----	--------	--------	--------------------------

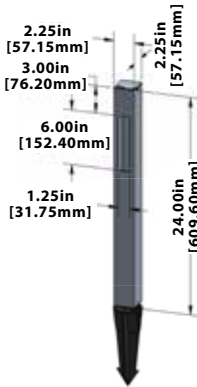

18" ALUMINUM OR BRASS BOLLARD, DECK MOUNT, 1 WINDOW, FLAT TOP							
PL23S1WDM18L50BLT	ALUMINUM	BLACK TEXTURE	7W MR16 LED 80°	3000K/550LM	GU5.3	\$165.00	
PL23S1WDM18NLBPBLT	ALUMINUM	BLACK TEXTURE	NO LAMP		GU5.3	\$132.00	
PL23S1WDM18L50BRS	BRASS	UNFINISHED	7W MR16 LED 80°	3000K/550LM	GU5.3	\$341.00	
PL23S1WDM18NLBPBRS	BRASS	UNFINISHED	NO LAMP		GU5.3	\$308.00	
24" ALUMINUM OR BRASS BOLLARD, DECK MOUNT, 1 WINDOW, FLAT TOP (SHOWN)							
PL23S1WDM24L50BLT	ALUMINUM	BLACK TEXTURE	7W MR16 LED 80°	3000K/550LM	GU5.3	\$176.00	
PL23S1WDM24NLBPBLT	ALUMINUM	BLACK TEXTURE	NO LAMP		GU5.3	\$143.00	
PL23S1WDM24L50BRS	BRASS	UNFINISHED	7W MR16 LED 80°	3000K/550LM	GU5.3	\$385.00	
PL23S1WDM24NLBPBRS	BRASS	UNFINISHED	NO LAMP		GU5.3	\$363.00	
18" ALUMINUM OR BRASS BOLLARD, LED PANEL, DECK MOUNT, 1 WINDOW, FLAT TOP							
PL23S1WDM18LEDPBLT	ALUMINUM	BLACK TEXTURE	4W LED PANEL	3000K/300LM	NONE	\$209.00	
PL23S1WDM18LEDPBRS	BRASS	UNFINISHED	4W LED PANEL	3000K/300LM	NONE	\$385.00	
24" ALUMINUM OR BRASS BOLLARD, LED PANEL, DECK MOUNT, 1 WINDOW, FLAT TOP							
PL23S1WDM24LEDPBLT	ALUMINUM	BLACK TEXTURE	4W LED PANEL	3000K/300LM	NONE	\$222.00	
PL23S1WDM24LEDPBRS	BRASS	UNFINISHED	4W LED PANEL	3000K/300LM	NONE	\$440.00	

FINISHES: (SEE PAGE 49 FOR MORE INFORMATION)

ADD ON COST FOR OPTIONAL FINISHES	\$11.00
ADD ON COST FOR PREMIUM COLOR BKM	\$19.80
ADD ON COST FOR PREMIUM COLOR DBZ	\$17.60
ADD ON COST FOR ACID TREATMENT OF BRASS	\$33.00

*NOTE: CUSTOM PRODUCT CONFIGURATIONS, PAINT FINISHES, AND ACID TREATMENTS ARE AVAILABLE; BUT NON RETURNABLE

120V OPTION (SEE PAGE 51 FOR MORE INFORMATION)

CHANGE TO GU10 SOCKET - FOR LAMPS: L106, L108, L110, L114, L116, L118, L124, L128	\$11.00
---	---------



POWER SUPPLY:

120V-277V USES P/N HW1260LED277R1 TRANSFORMER INSTALLED IN WEATHERPROOF JUNCTION BOX NO MORE THAN 18' FROM FIXTURE	\$99.00
--	---------

12V-277V	PL23S2/PL23S2LEDP SQUARE BOLLARD	MATERIAL	FINISH	LED	CCT/LM	SOCKET	CURRENT LIST PRICE USD\$
----------	----------------------------------	----------	--------	-----	--------	--------	--------------------------

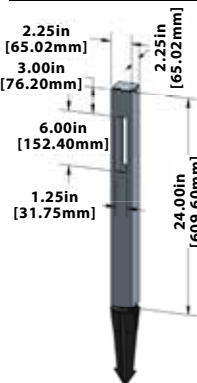

18" ALUMINUM OR BRASS BOLLARD, DECK MOUNT, 2 WINDOW, FLAT TOP							
PL23S2WDM18L50BLT	ALUMINUM	BLACK TEXTURE	7W MR16 LED 80°	3000K/550LM	GU5.3	\$187.00	
PL23S2WDM18NLBPBLT	ALUMINUM	BLACK TEXTURE	NO LAMP		GU5.3	\$154.00	
PL23S2WDM18L50BRS	BRASS	UNFINISHED	7W MR16 LED 80°	3000K/550LM	GU5.3	\$363.00	
PL23S2WDM18NLBPBRS	BRASS	UNFINISHED	NO LAMP		GU5.3	\$330.00	
24" ALUMINUM OR BRASS BOLLARD, DECK MOUNT, 2 WINDOW, FLAT TOP (SHOWN)							
PL23S2WDM24L50BLT	ALUMINUM	BLACK TEXTURE	7W MR16 LED 80°	3000K/550LM	GU5.3	\$198.00	
PL23S2WDM24NLBPBLT	ALUMINUM	BLACK TEXTURE	NO LAMP		GU5.3	\$165.00	
PL23S2WDM24L50BRS	BRASS	UNFINISHED	7W MR16 LED 80°	3000K/550LM	GU5.3	\$418.00	
PL23S2WDM24NLBPBRS	BRASS	UNFINISHED	NO LAMP		GU5.3	\$385.00	
18" ALUMINUM OR BRASS BOLLARD, LED PANEL, DECK MOUNT, 2 WINDOW, FLAT TOP							
PL23S2WDM18LEDPBLT	ALUMINUM	BLACK TEXTURE	4W LED PANEL	3000K/300LM	NONE	\$231.00	
PL23S2WDM18LEDPBRS	BRASS	UNFINISHED	4W LED PANEL	3000K/300LM	NONE	\$407.00	
24" ALUMINUM OR BRASS BOLLARD, LED PANEL, DECK MOUNT, 2 WINDOW, FLAT TOP							
PL23S2WDM24LEDPBLT	ALUMINUM	BLACK TEXTURE	4W LED PANEL	3000K/300LM	NONE	\$242.00	
PL23S2WDM24LEDPBRS	BRASS	UNFINISHED	4W LED PANEL	3000K/300LM	NONE	\$462.00	

FINISHES: (SEE PAGE 49 FOR MORE INFORMATION)

ADD ON COST FOR OPTIONAL FINISHES	\$11.00
ADD ON COST FOR PREMIUM COLOR BKM	\$19.80
ADD ON COST FOR PREMIUM COLOR DBZ	\$17.60
ADD ON COST FOR ACID TREATMENT OF BRASS	\$33.00

*NOTE: CUSTOM PRODUCT CONFIGURATIONS, PAINT FINISHES, AND ACID TREATMENTS ARE AVAILABLE; BUT NON RETURNABLE

120V OPTION (SEE PAGE 51 FOR MORE INFORMATION)

CHANGE TO GU10 SOCKET - FOR LAMPS: L106, L108, L110, L114, L116, L118, L124, L128	\$11.00
---	---------



POWER SUPPLY:

120V-277V USES P/N HW1260LED277R1 TRANSFORMER INSTALLED IN WEATHERPROOF JUNCTION BOX NO MORE THAN 18' FROM FIXTURE	\$99.00
--	---------

12V-277V PL23S3/PL23S3LEDP SQUARE BOLLARD	MATERIAL	FINISH	LED	CCT/LM	SOCKET	CURRENT LIST PRICE USD\$
--	----------	--------	-----	--------	--------	-----------------------------

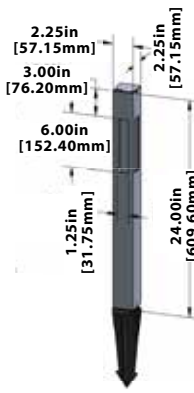

18" ALUMINUM or BRASS BOLLARD, DECK MOUNT, 3 WINDOW, FLAT TOP						
PL23S3WDM18L50BLT	ALUMINUM	BLACK TEXTURE	7W MR16 LED 80°	3000K/550LM	GU5.3	\$209.00
PL23S3WDM18NLBPBLT	ALUMINUM	BLACK TEXTURE	NO LAMP		GU5.3	\$176.00
PL23S3WDM18L50BRS	BRASS	UNFINISHED	7W MR16 LED 80°	3000K/550LM	GU5.3	\$385.00
PL23S3WDM18NLBPBRS	BRASS	UNFINISHED	NO LAMP		GU5.3	\$352.00
24" ALUMINUM or BRASS BOLLARD, DECK MOUNT, 3 WINDOW, FLAT TOP (SHOWN)						
PL23S3WDM24L50BLT	ALUMINUM	BLACK TEXTURE	7W MR16 LED 80°	3000K/550LM	GU5.3	\$220.00
PL23S3WDM24NLBPBLT	ALUMINUM	BLACK TEXTURE	NO LAMP		GU5.3	\$187.00
PL23S3WDM24L50BRS	BRASS	UNFINISHED	7W MR16 LED 80°	3000K/550LM	GU5.3	\$440.00
PL23S3WDM24NLBPBRS	BRASS	UNFINISHED	NO LAMP		GU5.3	\$407.00
18" ALUMINUM or BRASS BOLLARD, LED PANEL, DECK MOUNT, 3 WINDOW, FLAT TOP						
PL23S3WDM18LEDPBLT	ALUMINUM	BLACK TEXTURE	4W LED PANEL	3000K/300LM	NONE	\$253.00
PL23S3WDM18LEDPBRS	BRASS	UNFINISHED	4W LED PANEL	3000K/300LM	NONE	\$429.00
24" ALUMINUM or BRASS BOLLARD, LED PANEL, DECK MOUNT, 3 WINDOW, FLAT TOP						
PL23S3WDM24LEDPBLT	ALUMINUM	BLACK TEXTURE	4W LED PANEL	3000K/300LM	NONE	\$264.00
PL23S3WDM24LEDPBRS	BRASS	UNFINISHED	4W LED PANEL	3000K/300LM	NONE	\$484.00

FINISHES: (SEE PAGE 49 FOR MORE INFORMATION)

ADD ON COST FOR OPTIONAL FINISHES	\$11.00
ADD ON COST FOR PREMIUM COLOR BKM	\$19.80
ADD ON COST FOR PREMIUM COLOR DBZ	\$17.60
ADD ON COST FOR ACID TREATMENT OF BRASS	\$33.00

*NOTE: CUSTOM PRODUCT CONFIGURATIONS, PAINT FINISHES, AND ACID TREATMENTS ARE AVAILABLE; BUT NON RETURNABLE

120V OPTION (SEE PAGE 51 FOR MORE INFORMATION)

CHANGE TO GU10 SOCKET - FOR LAMPS: L106, L108, L110, L114, L116, L118, L124, L128	\$11.00
---	---------



POWER SUPPLY:

120V-277V USES P/N HW1260LED277R1 TRANSFORMER INSTALLED IN WEATHERPROOF JUNCTION BOX NO MORE THAN 18' FROM FIXTURE	\$99.00
--	---------

12V-277V PL23S4/PL23S4LEDP SQUARE BOLLARD	MATERIAL	FINISH	LED	CCT/LM	SOCKET	CURRENT LIST PRICE USD\$
--	----------	--------	-----	--------	--------	-----------------------------

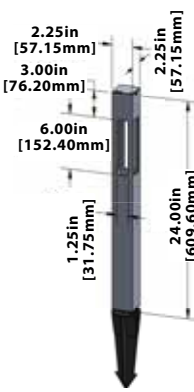

18" ALUMINUM OR BRASS BOLLARD, DECK MOUNT, 4 WINDOW, FLAT TOP						
PL23S4WDM18L50BLT	ALUMINUM	BLACK TEXTURE	7W MR16 LED 80°	3000K/550LM	GU5.3	\$231.00
PL23S4WDM18NLBPBLT	ALUMINUM	BLACK TEXTURE	NO LAMP		GU5.3	\$198.00
PL23S4WDM18L50BRS	BRASS	UNFINISHED	7W MR16 LED 80°	3000K/550LM	GU5.3	\$407.00
PL23S4WDM18NLBPBRS	BRASS	UNFINISHED	NO LAMP		GU5.3	\$374.00
24" ALUMINUM OR BRASS BOLLARD, DECK MOUNT, 4 WINDOW, FLAT TOP (SHOWN)						
PL23S4WDM24L50BLT	ALUMINUM	BLACK TEXTURE	7W MR16 LED 80°	3000K/550LM	GU5.3	\$242.00
PL23S4WDM24NLBPBLT	ALUMINUM	BLACK TEXTURE	NO LAMP		GU5.3	\$209.00
PL23S4WDM24L50BRS	BRASS	UNFINISHED	7W MR16 LED 80°	3000K/550LM	GU5.3	\$462.00
PL23S4WDM24NLBPBRS	BRASS	UNFINISHED	NO LAMP		GU5.3	\$429.00
18" ALUMINUM OR BRASS BOLLARD, LED PANEL, DECK MOUNT, 4 WINDOW, FLAT TOP						
PL23S4WDM18LEDPBLT	ALUMINUM	BLACK TEXTURE	4W LED PANEL	3000K/300LM	NONE	\$275.00
PL23S4WDM18LEDPBRS	BRASS	UNFINISHED	4W LED PANEL	3000K/300LM	NONE	\$451.00
24" ALUMINUM OR BRASS BOLLARD, LED PANEL, DECK MOUNT, 4 WINDOW, FLAT TOP						
PL23S4WDM24LEDPBLT	ALUMINUM	BLACK TEXTURE	4W LED PANEL	3000K/300LM	NONE	\$286.00
PL23S4WDM24LEDPBRS	BRASS	UNFINISHED	4W LED PANEL	3000K/300LM	NONE	\$451.00

FINISHES: (SEE PAGE 49 FOR MORE INFORMATION)

ADD ON COST FOR OPTIONAL FINISHES	\$11.00
ADD ON COST FOR PREMIUM COLOR BKM	\$19.80
ADD ON COST FOR PREMIUM COLOR DBZ	\$17.60
ADD ON COST FOR ACID TREATMENT OF BRASS	\$33.00

*NOTE: CUSTOM PRODUCT CONFIGURATIONS, PAINT FINISHES, AND ACID TREATMENTS ARE AVAILABLE; BUT NON RETURNABLE

120V OPTION (SEE PAGE 51 FOR MORE INFORMATION)

CHANGE TO GU10 SOCKET - FOR LAMPS: L106, L108, L110, L114, L116, L118, L124, L128	\$11.00
---	---------



POWER SUPPLY:

120V-277V USES P/N HW1260LED277R1 TRANSFORMER INSTALLED IN WEATHERPROOF JUNCTION BOX NO MORE THAN 18' FROM FIXTURE	\$99.00
--	---------

12V-277V PL23LG	SQUARE BOLLARD	MATERIAL	FINISH	LED	CCT/LM	SOCKET	CURRENT LIST PRICE USD\$
--------------------	----------------	----------	--------	-----	--------	--------	--------------------------

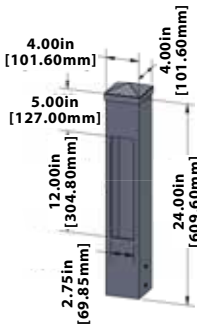

4" SQUARE, DECK MOUNT BASE, 24" BOLLARD, ANGLE TOP, STAINLESS STEEL U-BRACKET, 12V (SHOWN)							
PL23LGDM24ATL24BLT	ALUMINUM	BLACK TEXTURE	3W MR16 SS LED 36°	3000K/270LM	GU5.3	\$335.50	
4" SQUARE, DECK MOUNT BASE, 24" BOLLARD, ANGLE TOP, STAINLESS STEEL U-BRACKET, 120V							
PL23LGDM24ATL108BLT	ALUMINUM	BLACK TEXTURE	3W MR16 SS LED 36°	3000K/270LM	GU10	\$349.80	

*NOTE: ANGLE TOP AVAILABLE IN ALUMINUM ONLY

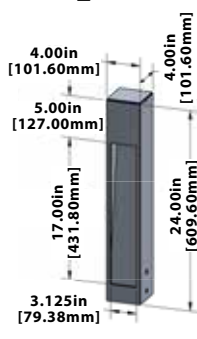

4" SQUARE, DECK MOUNT BASE, 24" BOLLARD, FLAT TOP, STAINLESS STEEL U-BRACKET, 12V (SHOWN)							
PL23LGDM24L24BLT	ALUMINUM	BLACK TEXTURE	3W MR16 SS LED 36°	3000K/270LM	GU5.3	\$330.00	
PL23LGDM24L24BRS	BRASS	UNFINISHED	3W MR16 SS LED 36°	3000K/270LM	GU5.3	\$676.50	
4" SQUARE, DECK MOUNT BASE, 24" BOLLARD, FLAT TOP, STAINLESS STEEL U-BRACKET, 120V							
PL23LGDM24L108BLT	ALUMINUM	BLACK TEXTURE	3W MR16 SS LED 36°	3000K/270LM	GU10	\$344.30	
PL23LGDM24L108BRS	BRASS	UNFINISHED	3W MR16 SS LED 36°	3000K/270LM	GU10	\$690.80	

24" FIXTURE ADD ON COST FOR ACID TREATMENT OF BRASS

\$48.00

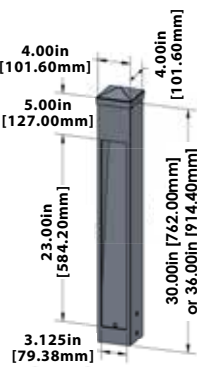

4" SQUARE, DECK MOUNT BASE, 30" BOLLARD, ANGLE TOP, STAINLESS STEEL U-BRACKET, 12V (SHOWN)							
PL23LGDM30ATL24BLT	ALUMINUM	BLACK TEXTURE	3W MR16 SS LED 36°	3000K/270LM	GU5.3	\$390.50	
4" SQUARE, DECK MOUNT BASE, 30" BOLLARD, ANGLE TOP, STAINLESS STEEL U-BRACKET, 120V							
PL23LGDM30ATL108BLT	ALUMINUM	BLACK TEXTURE	3W MR16 SS LED 36°	3000K/270LM	GU10	\$404.80	

4" SQUARE, DECK MOUNT BASE, 36" BOLLARD, ANGLE TOP, STAINLESS STEEL U-BRACKET, 12V (SHOWN)							
PL23LGDM36ATL24BLT	ALUMINUM	BLACK TEXTURE	3W MR16 SS LED 36°	3000K/270LM	GU5.3	\$429.00	
4" SQUARE, DECK MOUNT BASE, 36" BOLLARD, ANGLE TOP, STAINLESS STEEL U-BRACKET, 120V							
PL23LGDM36ATL108BLT	ALUMINUM	BLACK TEXTURE	3W MR16 SS LED 36°	3000K/270LM	GU10	\$443.30	

*NOTE: ANGLE TOP AVAILABLE IN ALUMINUM ONLY

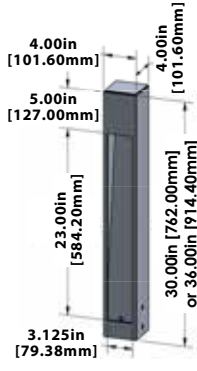

4" SQUARE, DECK MOUNT BASE, 30" BOLLARD, FLAT TOP, STAINLESS STEEL U-BRACKET, 12V (SHOWN)							
PL23LGDM30L24BLT	ALUMINUM	BLACK TEXTURE	3W MR16 SS LED 36°	3000K/270LM	GU5.3	\$385.00	
PL23LGDM30L24BRS	BRASS	UNFINISHED	3W MR16 SS LED 36°	3000K/270LM	GU5.3	\$825.00	

30" FIXTURE ADD ON COST FOR ACID TREATMENT OF BRASS

\$58.00

4" SQUARE, DECK MOUNT BASE, 30" BOLLARD, FLAT TOP, STAINLESS STEEL U-BRACKET, 120V							
PL23LGDM30L108BLT	ALUMINUM	BLACK TEXTURE	3W MR16 SS LED 36°	3000K/270LM	GU10	\$399.30	
PL23LGDM30L108BRS	BRASS	UNFINISHED	3W MR16 SS LED 36°	3000K/270LM	GU10	\$839.30	

30" FIXTURE ADD ON COST FOR ACID TREATMENT OF BRASS

\$58.00

4" SQUARE, DECK MOUNT BASE, 36" BOLLARD, FLAT TOP, STAINLESS STEEL U-BRACKET, 12V							
PL23LGDM36L24BLT	ALUMINUM	BLACK TEXTURE	3W MR16 SS LED 36°	3000K/270LM	GU5.3	423.50	
PL23LGDM36L24BRS	BRASS	UNFINISHED	3W MR16 SS LED 36°	3000K/270LM	GU5.3	\$929.50	

30" FIXTURE ADD ON COST FOR ACID TREATMENT OF BRASS

\$58.00

4" SQUARE, DECK MOUNT BASE, 36" BOLLARD, FLAT TOP, STAINLESS STEEL U-BRACKET, 120V							
PL23LGDM36L108BLT	ALUMINUM	BLACK TEXTURE	3W MR16 SS LED 36°	3000K/270LM	GU10	\$437.80	
PL23LGDM36L108BRS	BRASS	UNFINISHED	3W MR16 SS LED 36°	3000K/270LM	GU10	\$943.80	

36" FIXTURE ADD ON COST FOR ACID TREATMENT OF BRASS

\$65.00

FINISHES: (SEE PAGE 49 FOR MORE INFORMATION)							
ADD ON COST FOR OPTIONAL FINISHES						\$22.00	
ADD ON COST FOR PREMIUM COLOR BKM						\$39.60	
ADD ON COST FOR PREMIUM COLOR DBZ						\$35.20	

*NOTE: CUSTOM PRODUCT CONFIGURATIONS, PAINT FINISHES, AND ACID TREATMENTS ARE AVAILABLE; BUT NON RETURNABLE

OPTIONAL MOUNTING DEVICES:							
FA033PBLK - 3 PRONG STAKE, STAINLESS STEEL, 1/2" NPS FEMALE THREADED, BLACK						\$56.25	
FAJBOX - CAST BRASS JUNCTION BOX, 1/2" NPS FEMALE THREADED ON COVER						\$198.00	
FA25BLT - 12V PVC MOUNTING PEDESTAL, ALUMINUM CAP, BLACK TEXTURE						\$55.00	
FA25BRS - 12V PVC MOUNTING PEDESTAL, BRASS CAP						\$75.90	
FA26BLT - 120V PVC MOUNTING PEDESTAL, ALUMINUM CAP, BLACK TEXTURE						\$56.10	
FA26BRS - 120V PVC MOUNTING PEDESTAL, BRASS CAP						\$79.20	

*NOTE: TO USE ANY OF THE ABOVE LISTED MOUNTING DEVICES, ADD FA1218 REDUCER

\$8.80

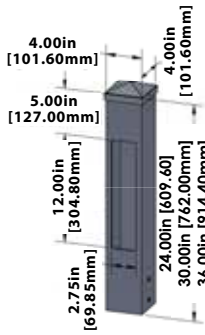

4" SQUARE, DECK MOUNT BASE, 24" BOLLARD, 1 WINDOW ANGLE TOP, STAINLESS STEEL U-BRACKET, 12V (SHOWN)							
PL23LGS1WDM24ATL24BLT	ALUMINUM	BLACK TEXTURE	7W MR16 LED 36°	3000K/550LM	GU5.3		\$308.00
4" SQUARE, DECK MOUNT BASE, 24" BOLLARD, 1 WINDOW ANGLE TOP, STAINLESS STEEL U-BRACKET, 120V							
PL23LGS1WDM24ATL108BLT	ALUMINUM	BLACK TEXTURE	7W MR16 LED 36°	3000K/550LM	GU10		\$322.30
4" SQUARE, DECK MOUNT BASE, 30" BOLLARD, 1 WINDOW ANGLE TOP, STAINLESS STEEL U-BRACKET, 12V							
PL23LGS1WDM30ATL24BLT	ALUMINUM	BLACK TEXTURE	7W MR16 LED 36°	3000K/550LM	GU5.3		\$330.00
4" SQUARE, DECK MOUNT BASE, 30" BOLLARD, 1 WINDOW ANGLE TOP, STAINLESS STEEL U-BRACKET, 120V							
PL23LGS1WDM30ATL108BLT	ALUMINUM	BLACK TEXTURE	7W MR16 LED 36°	3000K/550LM	GU10		\$344.30
4" SQUARE, DECK MOUNT BASE, 36" BOLLARD, 1 WINDOW ANGLE TOP, STAINLESS STEEL U-BRACKET, 12V							
PL23LGS1WDM36ATL24BLT	ALUMINUM	BLACK TEXTURE	7W MR16 LED 36°	3000K/550LM	GU5.3		\$352.00
4" SQUARE, DECK MOUNT BASE, 36" BOLLARD, 1 WINDOW ANGLE TOP, STAINLESS STEEL U-BRACKET, 120V							
PL23LGS1WDM36ATL108BLT	ALUMINUM	BLACK TEXTURE	7W MR16 LED 36°	3000K/550LM	GU10		\$366.30

*NOTE: ANGLE TOP AVAILABLE IN ALUMINUM ONLY

FINISHES: (SEE PAGE 49 FOR MORE INFORMATION)

ADD ON COST FOR OPTIONAL FINISHES	\$22.00
ADD ON COST FOR PREMIUM COLOR BKM	\$39.60
ADD ON COST FOR PREMIUM COLOR DBZ	\$35.20

*NOTE: CUSTOM PRODUCT CONFIGURATIONS, PAINT FINISHES, AND ACID TREATMENTS ARE AVAILABLE; BUT NON RETURNABLE

OPTIONAL MOUNTING DEVICES:

FA033PBLK - 3 PRONG STAKE. STAINLESS STEEL, 1/2" NPS FEMALE THREADED. BLACK	\$56.25
FAJBOX - CAST BRASS JUNCTION BOX, 1/2" NPS FEMALE THREADED ON COVER	\$198.00
FA25BLT - 12V PVC MOUNTING PEDESTAL. ALUMINUM CAP. BLACK TEXTURE	\$55.00
FA25BRS - 12V PVC MOUNTING PEDESTAL. BRASS CAP.	\$75.90
FA26BLT - 120V PVC MOUNTING PEDESTAL. ALUMINUM CAP. BLACK TEXTURE	\$56.10
FA26BRS - 120V PVC MOUNTING PEDESTAL. BRASS CAP	\$79.20
*NOTE: TO USE ANY OF THE ABOVE LISTED MOUNTING DEVICES, ADD FA1218 REDUCER	\$8.80

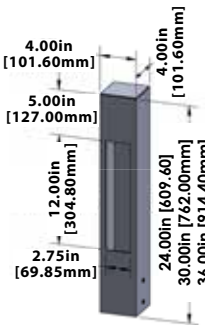

4" SQUARE, DECK MOUNT BASE, 24" BOLLARD, 1 WINDOW FLAT TOP, STAINLESS STEEL U-BRACKET, 12V (SHOWN)							
PL23LGS1WDM24L24BLT	ALUMINUM	BLACK TEXTURE	7W MR16 LED 36°	3000K/550LM	GU5.3		\$291.50
PL23LGS1WDM24L24BRS	BRASS	UNFINISHED	7W MR16 LED 36°	3000K/550LM	GU5.3		\$599.50
4" SQUARE, DECK MOUNT BASE, 24" BOLLARD, 1 WINDOW FLAT TOP, STAINLESS STEEL U-BRACKET, 120V							
PL23LGS1WDM24L108BLT	ALUMINUM	BLACK TEXTURE	7W MR16 LED 36°	3000K/550LM	GU10		\$305.80
PL23LGS1WDM24L108BRS	BRASS	UNFINISHED	7W MR16 LED 36°	3000K/550LM	GU10		\$613.80
24" FIXTURE ADD ON COST FOR ACID TREATMENT OF BRASS							\$48.00
4" SQUARE, DECK MOUNT BASE, 30" BOLLARD, 1 WINDOW FLAT TOP, STAINLESS STEEL U-BRACKET, 12V							
PL23LGS1WDM30L24BLT	ALUMINUM	BLACK TEXTURE	7W MR16 LED 36°	3000K/550LM	GU5.3		\$319.00
PL23LGS1WDM30L24BRS	BRASS	UNFINISHED	7W MR16 LED 36°	3000K/550LM	GU5.3		\$682.00
4" SQUARE, DECK MOUNT BASE, 30" BOLLARD, 1 WINDOW FLAT TOP, STAINLESS STEEL U-BRACKET, 120V							
PL23LGS1WDM30L108BLT	ALUMINUM	BLACK TEXTURE	7W MR16 LED 36°	3000K/550LM	GU10		\$330.30
PL23LGS1WDM30L108BRS	BRASS	UNFINISHED	7W MR16 LED 36°	3000K/550LM	GU10		\$696.30
30" FIXTURE ADD ON COST FOR ACID TREATMENT OF BRASS							\$58.00
4" SQUARE, DECK MOUNT BASE, 36" BOLLARD, 1 WINDOW FLAT TOP, STAINLESS STEEL U-BRACKET, 12V							
PL23LGS1WDM36L24BLT	ALUMINUM	BLACK TEXTURE	7W MR16 LED 36°	3000K/550LM	GU5.3		\$346.50
PL23LGS1WDM36L24BRS	BRASS	UNFINISHED	7W MR16 LED 36°	3000K/550LM	GU5.3		\$770.00
4" SQUARE, DECK MOUNT BASE, 36" BOLLARD, 1 WINDOW FLAT TOP, STAINLESS STEEL U-BRACKET, 120V							
PL23LGS1WDM306TL108BLT	ALUMINUM	BLACK TEXTURE	7W MR16 LED 36°	3000K/550LM	GU10		\$360.80
PL23LGS1WDM36L108BRS	BRASS	UNFINISHED	7W MR16 LED 36°	3000K/550LM	GU10		\$784.30
36" FIXTURE ADD ON COST FOR ACID TREATMENT OF BRASS							\$65.00

FINISHES: (SEE PAGE 49 FOR MORE INFORMATION)

ADD ON COST FOR OPTIONAL FINISHES	\$22.00
ADD ON COST FOR PREMIUM COLOR BKM	\$39.60
ADD ON COST FOR PREMIUM COLOR DBZ	\$35.20

*NOTE: CUSTOM PRODUCT CONFIGURATIONS, PAINT FINISHES, AND ACID TREATMENTS ARE AVAILABLE; BUT NON RETURNABLE

OPTIONAL MOUNTING DEVICES:

FA033PBLK - 3 PRONG STAKE. STAINLESS STEEL, 1/2" NPS FEMALE THREADED. BLACK	\$56.25
FAJBOX - CAST BRASS JUNCTION BOX, 1/2" NPS FEMALE THREADED ON COVER	\$198.00
FA25BLT - 12V PVC MOUNTING PEDESTAL. ALUMINUM CAP. BLACK TEXTURE	\$55.00
FA25BRS - 12V PVC MOUNTING PEDESTAL. BRASS CAP.	\$75.90
FA26BLT - 120V PVC MOUNTING PEDESTAL. ALUMINUM CAP. BLACK TEXTURE	\$56.10
FA26BRS - 120V PVC MOUNTING PEDESTAL. BRASS CAP	\$79.20
*NOTE: TO USE ANY OF THE ABOVE LISTED MOUNTING DEVICES, ADD FA1218 REDUCER	\$8.80

12V-277V PL23LGS2	SQUARE BOLLARD	MATERIAL	FINISH	LED	CCT/LM	SOCKET	CURRENT LIST PRICE USD\$
----------------------	----------------	----------	--------	-----	--------	--------	-----------------------------

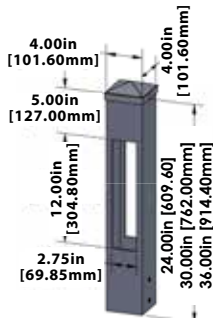

4" SQUARE, DECK MOUNT BASE, 24" BOLLARD, 2 WINDOW, ANGLE TOP, STAINLESS STEEL U-BRACKET, 12V (SHOWN)							
PL23LGS2WDM24ATL24BLT	ALUMINUM	BLACK TEXTURE	3W MR16 LED 36°	3000K/270LM	GU5.3	\$334.40	
4" SQUARE, DECK MOUNT BASE, 24" BOLLARD, 2 WINDOW, ANGLE TOP, STAINLESS STEEL U-BRACKET, 120V							
PL23LGS2WDM24ATL108BLT	ALUMINUM	BLACK TEXTURE	3W MR16 LED 36°	3000K/270LM	GU10	\$348.70	
4" SQUARE, DECK MOUNT BASE, 30" BOLLARD, 2 WINDOW, ANGLE TOP, STAINLESS STEEL U-BRACKET, 12V							
PL23LGS2WDM30ATL24BLT	ALUMINUM	BLACK TEXTURE	3W MR16 LED 36°	3000K/270LM	GU5.3	\$356.40	
4" SQUARE, DECK MOUNT BASE, 30" BOLLARD, 2 WINDOW, ANGLE TOP, STAINLESS STEEL U-BRACKET, 120V							
PL23LGS2WDM30ATL108BLT	ALUMINUM	BLACK TEXTURE	3W MR16 LED 36°	3000K/270LM	GU10	\$370.70	
4" SQUARE, DECK MOUNT BASE, 36" BOLLARD, 2 WINDOW, ANGLE TOP, STAINLESS STEEL U-BRACKET, 12V							
PL23LGS2WDM36ATL24BLT	ALUMINUM	BLACK TEXTURE	3W MR16 LED 36°	3000K/270LM	GU5.3	\$378.40	
4" SQUARE, DECK MOUNT BASE, 36" BOLLARD, 2 WINDOW, ANGLE TOP, STAINLESS STEEL U-BRACKET, 120V							
PL23LGS2WDM36ATL108BLT	ALUMINUM	BLACK TEXTURE	3W MR16 LED 36°	3000K/270LM	GU10	\$392.70	

*NOTE: ANGLE TOP AVAILABLE IN ALUMINUM ONLY

FINISHES: (SEE PAGE 49 FOR MORE INFORMATION)

ADD ON COST FOR OPTIONAL FINISHES	\$22.00
ADD ON COST FOR PREMIUM COLOR BKM	\$39.60
ADD ON COST FOR PREMIUM COLOR DBZ	\$35.20

*NOTE: CUSTOM PRODUCT CONFIGURATIONS, PAINT FINISHES, AND ACID TREATMENTS ARE AVAILABLE; BUT NON RETURNABLE

OPTIONAL MOUNTING DEVICES:

FA033PBLK - 3 PRONG STAKE. STAINLESS STEEL, 1/2" NPS FEMALE THREADED. BLACK	\$56.25
FAJBOX - CAST BRASS JUNCTION BOX, 1/2" NPS FEMALE THREADED ON COVER	\$198.00
FA25BLT - 12V PVC MOUNTING PEDESTAL. ALUMINUM CAP. BLACK TEXTURE	\$55.00
FA25BRS - 12V PVC MOUNTING PEDESTAL. BRASS CAP.	\$75.90
FA26BLT - 120V PVC MOUNTING PEDESTAL. ALUMINUM CAP. BLACK TEXTURE	\$56.10
FA26BRS - 120V PVC MOUNTING PEDESTAL. BRASS CAP	\$79.20
*NOTE: TO USE ANY OF THE ABOVE LISTED MOUNTING DEVICES, ADD FA1218 REDUCER	\$8.80

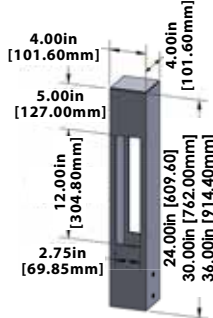

4" SQUARE, DECK MOUNT BASE, 24" BOLLARD, 2 WINDOW, FLAT TOP, STAINLESS STEEL U-BRACKET, 12V (SHOWN)							
PL23LGS2WDM24L24BLT	ALUMINUM	BLACK TEXTURE	3W MR16 LED 36°	3000K/270LM	GU5.3	\$317.90	
PL23LGS2WDM24L24BBS	BRASS	UNFINISHED	3W MR16 LED 36°	3000K/270LM	GU5.3	\$632.50	
24" FIXTURE ADD ON COST FOR ACID TREATMENT OF BRASS						\$45.10	
4" SQUARE, DECK MOUNT BASE, 24" BOLLARD, 2 WINDOW, FLAT TOP, STAINLESS STEEL U-BRACKET, 120V							
PL23LGS2WDM24L108BLT	ALUMINUM	BLACK TEXTURE	3W MR16 LED 36°	3000K/270LM	GU10	\$332.20	
PL23LGS2WDM24L108BRS	BRASS	UNFINISHED	3W MR16 LED 36°	3000K/270LM	GU10	\$646.80	
24" FIXTURE ADD ON COST FOR ACID TREATMENT OF BRASS						\$48.00	
4" SQUARE, DECK MOUNT BASE, 30" BOLLARD, 2 WINDOW, FLAT TOP, STAINLESS STEEL U-BRACKET, 12V							
PL23LGS2WDM30L24BLT	ALUMINUM	BLACK TEXTURE	3W MR16 LED 36°	3000K/270LM	GU5.3	\$345.40	
PL23LGS2WDM30L24BRS	BRASS	UNFINISHED	3W MR16 LED 36°	3000K/270LM	GU5.3	\$715.00	
30" FIXTURE ADD ON COST FOR ACID TREATMENT OF BRASS						\$52.80	
4" SQUARE, DECK MOUNT BASE, 30" BOLLARD, 2 WINDOW, FLAT TOP, STAINLESS STEEL U-BRACKET, 120V							
PL23LGS2WDM30L108BLT	ALUMINUM	BLACK TEXTURE	3W MR16 LED 36°	3000K/270LM	GU10	\$359.70	
PL23LGS2WDM30L108BRS	BRASS	UNFINISHED	3W MR16 LED 36°	3000K/270LM	GU10	\$729.30	
30" FIXTURE ADD ON COST FOR ACID TREATMENT OF BRASS						\$58.00	
4" SQUARE, DECK MOUNT BASE, 36" BOLLARD, 2 WINDOW, FLAT TOP, STAINLESS STEEL U-BRACKET, 12V							
PL23LGS2WDM36L24BLT	ALUMINUM	BLACK TEXTURE	3W MR16 LED 36°	3000K/270LM	GU5.3	\$372.90	
PL23LGS2WDM36L24BRS	BRASS	UNFINISHED	3W MR16 LED 36°	3000K/270LM	GU5.3	\$803.00	
36" FIXTURE ADD ON COST FOR ACID TREATMENT OF BRASS						\$60.50	
4" SQUARE, DECK MOUNT BASE, 36" BOLLARD, 2 WINDOW, FLAT TOP, STAINLESS STEEL U-BRACKET, 120V							
PL23LGS2WDM36L108BLT	ALUMINUM	BLACK TEXTURE	3W MR16 LED 36°	3000K/270LM	GU10	\$387.20	
PL23LGS2WDM36L108BRS	BRASS	UNFINISHED	3W MR16 LED 36°	3000K/270LM	GU10	\$817.30	
36" FIXTURE ADD ON COST FOR ACID TREATMENT OF BRASS						\$65.00	

FINISHES: (SEE PAGE 49 FOR MORE INFORMATION)

ADD ON COST FOR OPTIONAL FINISHES	\$22.00
ADD ON COST FOR PREMIUM COLOR BKM	\$39.60
ADD ON COST FOR PREMIUM COLOR DBZ	\$35.20

*NOTE: CUSTOM PRODUCT CONFIGURATIONS, PAINT FINISHES, AND ACID TREATMENTS ARE AVAILABLE; BUT NON RETURNABLE

OPTIONAL MOUNTING DEVICES:

FA033PBLK - 3 PRONG STAKE. STAINLESS STEEL, 1/2" NPS FEMALE THREADED. BLACK	\$56.25
FAJBOX - CAST BRASS JUNCTION BOX, 1/2" NPS FEMALE THREADED ON COVER	\$198.00
FA25BLT - 12V PVC MOUNTING PEDESTAL. ALUMINUM CAP. BLACK TEXTURE	\$55.00
FA25BRS - 12V PVC MOUNTING PEDESTAL. BRASS CAP.	\$75.90
FA26BLT - 120V PVC MOUNTING PEDESTAL. ALUMINUM CAP. BLACK TEXTURE	\$56.10
FA26BRS - 120V PVC MOUNTING PEDESTAL. BRASS CAP	\$79.20
*NOTE: TO USE ANY OF THE ABOVE LISTED MOUNTING DEVICES, ADD FA1218 REDUCER	\$8.80

12V-277V PL23LGS3	SQUARE BOLLARD	MATERIAL	FINISH	LED	CCT/LM	SOCKET	CURRENT LIST PRICE USD\$
----------------------	----------------	----------	--------	-----	--------	--------	-----------------------------

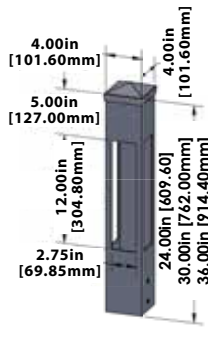

4" SQUARE, DECK MOUNT BASE, 24" BOLLARD, 3 WINDOW, ANGLE TOP, STAINLESS STEEL U-BRACKET, 12V (SHOWN)							
PL23LGS3WDM24ATL24BLT	ALUMINUM	BLACK TEXTURE	3W MR16 LED 36°	3000K/270LM	GU5.3	\$360.80	
4" SQUARE, DECK MOUNT BASE, 24" BOLLARD, 3 WINDOW, ANGLE TOP, STAINLESS STEEL U-BRACKET, 120V							
PL23LGS3WDM24ATL108BLT	ALUMINUM	BLACK TEXTURE	3W MR16 LED 36°	3000K/270LM	GU10	\$375.10	
4" SQUARE, DECK MOUNT BASE, 30" BOLLARD, 3 WINDOW, ANGLE TOP, STAINLESS STEEL U-BRACKET, 12V							
PL23LGS3WDM30ATL24BLT	ALUMINUM	BLACK TEXTURE	3W MR16 LED 36°	3000K/270LM	GU5.3	\$382.80	
4" SQUARE, DECK MOUNT BASE, 30" BOLLARD, 3 WINDOW, ANGLE TOP, STAINLESS STEEL U-BRACKET, 120V							
PL23LGS3WDM30ATL108BLT	ALUMINUM	BLACK TEXTURE	3W MR16 LED 36°	3000K/270LM	GU10	\$397.10	
4" SQUARE, DECK MOUNT BASE, 36" BOLLARD, 3 WINDOW, ANGLE TOP, STAINLESS STEEL U-BRACKET, 12V							
PL23LGS3WDM36ATL24BLT	ALUMINUM	BLACK TEXTURE	3W MR16 LED 36°	3000K/270LM	GU5.3	\$404.80	
4" SQUARE, DECK MOUNT BASE, 36" BOLLARD, 3 WINDOW, ANGLE TOP, STAINLESS STEEL U-BRACKET, 120V							
PL23LGS3WDM36ATL108BLT	ALUMINUM	BLACK TEXTURE	3W MR16 LED 36°	3000K/270LM	GU10	\$419.10	

*NOTE: ANGLE TOP AVAILABLE IN ALUMINUM ONLY

FINISHES: (SEE PAGE 49 FOR MORE INFORMATION)

ADD ON COST FOR OPTIONAL FINISHES	\$22.00
ADD ON COST FOR PREMIUM COLOR BKM	\$39.60
ADD ON COST FOR PREMIUM COLOR DBZ	\$35.20

*NOTE: CUSTOM PRODUCT CONFIGURATIONS, PAINT FINISHES, AND ACID TREATMENTS ARE AVAILABLE; BUT NON RETURNABLE

OPTIONAL MOUNTING DEVICES:

FA033PBLK - 3 PRONG STAKE, STAINLESS STEEL, 1/2" NPS FEMALE THREADED, BLACK	\$56.25
FAJBOX - CAST BRASS JUNCTION BOX, 1/2" NPS FEMALE THREADED ON COVER	\$198.00
FA25BLT - 12V PVC MOUNTING PEDESTAL, ALUMINUM CAP, BLACK TEXTURE	\$55.00
FA25BRS - 12V PVC MOUNTING PEDESTAL, BRASS CAP	\$75.90
FA26BLT - 120V PVC MOUNTING PEDESTAL, ALUMINUM CAP, BLACK TEXTURE	\$56.10
FA26BRS - 120V PVC MOUNTING PEDESTAL, BRASS CAP	\$79.20
*NOTE: TO USE ANY OF THE ABOVE LISTED MOUNTING DEVICES, ADD FA1218 REDUCER	\$8.80

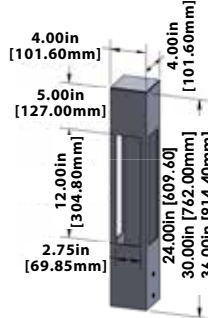

4" SQUARE, DECK MOUNT BASE, 24" BOLLARD, 3 WINDOW, FLAT TOP, STAINLESS STEEL U-BRACKET, 12V (SHOWN)							
PL23LGS3WDM24L24BLT	ALUMINUM	BLACK TEXTURE	3W MR16 LED 36°	3000K/270LM	GU5.3	\$344.30	
PL23LGS3WDM24L24BRS	BRASS	UNFINISHED	3W MR16 LED 36°	3000K/270LM	GU5.3	\$665.50	
24" FIXTURE ADD ON COST FOR ACID TREATMENT OF BRASS							
4" SQUARE, DECK MOUNT BASE, 24" BOLLARD, 3 WINDOW, FLAT TOP, STAINLESS STEEL U-BRACKET, 120V							
PL23LGS3WDM24L108BLT	ALUMINUM	BLACK TEXTURE	3W MR16 LED 36°	3000K/270LM	GU10	\$358.60	
PL23LGS3WDM24L108BRS	BRASS	UNFINISHED	3W MR16 LED 36°	3000K/270LM	GU10	\$679.80	
24" FIXTURE ADD ON COST FOR ACID TREATMENT OF BRASS							
4" SQUARE, DECK MOUNT BASE, 30" BOLLARD, 3 WINDOW, FLAT TOP, STAINLESS STEEL U-BRACKET, 12V							
PL23LGS3WDM30L24BLT	ALUMINUM	BLACK TEXTURE	3W MR16 LED 36°	3000K/270LM	GU5.3	\$371.80	
PL23LGS3WDM30L24BRS	BRASS	UNFINISHED	3W MR16 LED 36°	3000K/270LM	GU5.3	\$748.00	
30" FIXTURE ADD ON COST FOR ACID TREATMENT OF BRASS							
4" SQUARE, DECK MOUNT BASE, 30" BOLLARD, 3 WINDOW, FLAT TOP, STAINLESS STEEL U-BRACKET, 120V							
PL23LGS3WDM30L108BLT	ALUMINUM	BLACK TEXTURE	3W MR16 LED 36°	3000K/270LM	GU10	\$386.10	
PL23LGS3WDM30L108BRS	BRASS	UNFINISHED	3W MR16 LED 36°	3000K/270LM	GU10	\$762.30	
30" FIXTURE ADD ON COST FOR ACID TREATMENT OF BRASS							
4" SQUARE, DECK MOUNT BASE, 36" BOLLARD, 3 WINDOW, FLAT TOP, STAINLESS STEEL U-BRACKET, 12V							
PL23LGS3WDM36L24BLT	ALUMINUM	BLACK TEXTURE	3W MR16 LED 36°	3000K/270LM	GU5.3	\$399.30	
PL23LGS3WDM36L24BRS	BRASS	UNFINISHED	3W MR16 LED 36°	3000K/270LM	GU5.3	\$836.00	
36" FIXTURE ADD ON COST FOR ACID TREATMENT OF BRASS							
4" SQUARE, DECK MOUNT BASE, 36" BOLLARD, 3 WINDOW, FLAT TOP, STAINLESS STEEL U-BRACKET, 120V							
PL23LGS3WDM36L108BLT	ALUMINUM	BLACK TEXTURE	3W MR16 LED 36°	3000K/270LM	GU10	\$413.60	
PL23LGS3WDM36L108BRS	BRASS	UNFINISHED	3W MR16 LED 36°	3000K/270LM	GU10	\$850.30	
36" FIXTURE ADD ON COST FOR ACID TREATMENT OF BRASS							

FINISHES: (SEE PAGE 49 FOR MORE INFORMATION)

ADD ON COST FOR OPTIONAL FINISHES	\$22.00
ADD ON COST FOR PREMIUM COLOR BKM	\$39.60
ADD ON COST FOR PREMIUM COLOR DBZ	\$35.20

*NOTE: CUSTOM PRODUCT CONFIGURATIONS, PAINT FINISHES, AND ACID TREATMENTS ARE AVAILABLE; BUT NON RETURNABLE

OPTIONAL MOUNTING DEVICES:

FA033PBLK - 3 PRONG STAKE, STAINLESS STEEL, 1/2" NPS FEMALE THREADED, BLACK	\$56.25
FAJBOX - CAST BRASS JUNCTION BOX, 1/2" NPS FEMALE THREADED ON COVER	\$198.00
FA25BLT - 12V PVC MOUNTING PEDESTAL, ALUMINUM CAP, BLACK TEXTURE	\$55.00
FA25BRS - 12V PVC MOUNTING PEDESTAL, BRASS CAP	\$75.90
FA26BLT - 120V PVC MOUNTING PEDESTAL, ALUMINUM CAP, BLACK TEXTURE	\$56.10
FA26BRS - 120V PVC MOUNTING PEDESTAL, BRASS CAP	\$79.20
*NOTE: TO USE ANY OF THE ABOVE LISTED MOUNTING DEVICES, ADD FA1218 REDUCER	\$8.80

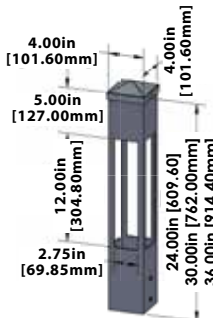

4" SQUARE, DECK MOUNT BASE, 24" BOLLARD, 4 WINDOW, ANGLE TOP, STAINLESS STEEL U-BRACKET, 12V (SHOWN)							
PL23LGS4WDM24ATL24BLT	ALUMINUM	BLACK TEXTURE	3W MR16 LED 36°	3000K/270LM	GU5.3	\$387.20	
4" SQUARE, DECK MOUNT BASE, 24" BOLLARD, 4 WINDOW, ANGLE TOP, STAINLESS STEEL U-BRACKET, 120V							
PL23LGS4WDM24ATL108BLT	ALUMINUM	BLACK TEXTURE	3W MR16 LED 36°	3000K/270LM	GU10	\$401.50	
4" SQUARE, DECK MOUNT BASE, 30" BOLLARD, 4 WINDOW, ANGLE TOP, STAINLESS STEEL U-BRACKET, 12V							
PL23LGS4WDM30ATL24BLT	ALUMINUM	BLACK TEXTURE	3W MR16 LED 36°	3000K/270LM	GU5.3	\$409.20	
4" SQUARE, DECK MOUNT BASE, 30" BOLLARD, 4 WINDOW, ANGLE TOP, STAINLESS STEEL U-BRACKET, 120V							
PL23LGS4WDM30ATL108BLT	ALUMINUM	BLACK TEXTURE	3W MR16 LED 36°	3000K/270LM	GU10	\$423.50	
4" SQUARE, DECK MOUNT BASE, 36" BOLLARD, 4 WINDOW, ANGLE TOP, STAINLESS STEEL U-BRACKET, 12V							
PL23LGS4WDM36ATL24BLT	ALUMINUM	BLACK TEXTURE	3W MR16 LED 36°	3000K/270LM	GU5.3	\$431.20	
4" SQUARE, DECK MOUNT BASE, 36" BOLLARD, 4 WINDOW, ANGLE TOP, STAINLESS STEEL U-BRACKET, 120V							
PL23LGS4WDM36ATL108BLT	ALUMINUM	BLACK TEXTURE	3W MR16 LED 36°	3000K/270LM	GU10	\$445.50	

*NOTE: ANGLE TOP AVAILABLE IN ALUMINUM ONLY

FINISHES: (SEE PAGE 49 FOR MORE INFORMATION)

ADD ON COST FOR OPTIONAL FINISHES	\$22.00
ADD ON COST FOR PREMIUM COLOR BKM	\$39.60
ADD ON COST FOR PREMIUM COLOR DBZ	\$35.20

*NOTE: CUSTOM PRODUCT CONFIGURATIONS, PAINT FINISHES, AND ACID TREATMENTS ARE AVAILABLE; BUT NON RETURNABLE

OPTIONAL MOUNTING DEVICES:

FA033PBLK - 3 PRONG STAKE. STAINLESS STEEL, 1/2" NPS FEMALE THREADED. BLACK	\$56.25
FAJBOX - CAST BRASS JUNCTION BOX, 1/2" NPS FEMALE THREADED ON COVER	\$198.00
FA25BLT - 12V PVC MOUNTING PEDESTAL. ALUMINUM CAP. BLACK TEXTURE	\$55.00
FA25BRS - 12V PVC MOUNTING PEDESTAL. BRASS CAP.	\$75.90
FA26BLT - 120V PVC MOUNTING PEDESTAL. ALUMINUM CAP. BLACK TEXTURE	\$56.10
FA26BRS - 120V PVC MOUNTING PEDESTAL. BRASS CAP	\$79.20
*NOTE: TO USE ANY OF THE ABOVE LISTED MOUNTING DEVICES, ADD FA1218 REDUCER	\$8.80

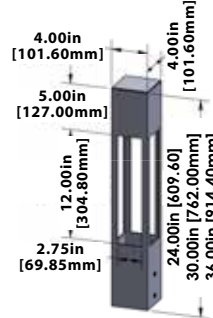

4" SQUARE, DECK MOUNT BASE, 24" BOLLARD, 4 WINDOW, FLAT TOP, STAINLESS STEEL U-BRACKET, 12V (SHOWN)							
PL23LGS4WDM24L24BLT	ALUMINUM	BLACK TEXTURE	3W MR16 LED 36°	3000K/270LM	GU5.3	\$370.70	
PL23LGS4WDM24L24BRS	BRASS	UNFINISHED	3W MR16 LED 36°	3000K/270LM	GU5.3	\$698.50	
24" FIXTURE ADD ON COST FOR ACID TREATMENT OF BRASS							
24" FIXTURE ADD ON COST FOR ACID TREATMENT OF BRASS							
4" SQUARE, DECK MOUNT BASE, 24" BOLLARD, 4 WINDOW, FLAT TOP, STAINLESS STEEL U-BRACKET INCLUDED, 120V							
PL23LGS4WDM24L108BLT	ALUMINUM	BLACK TEXTURE	3W MR16 LED 36°	3000K/270LM	GU10	\$385.00	
PL23LGS4WDM24L108BRS	BRASS	UNFINISHED	3W MR16 LED 36°	3000K/270LM	GU10	\$712.80	
24" FIXTURE ADD ON COST FOR ACID TREATMENT OF BRASS							
4" SQUARE, DECK MOUNT BASE, 30" BOLLARD, 4 WINDOW, FLAT TOP, STAINLESS STEEL U-BRACKET, 12V							
PL23LGS4WDM30L24BLT	ALUMINUM	BLACK TEXTURE	3W MR16 LED 36°	3000K/270LM	GU5.3	\$398.20	
PL23LGS4WDM30L24BRS	BRASS	UNFINISHED	3W MR16 LED 36°	3000K/270LM	GU5.3	\$781.00	
30" FIXTURE ADD ON COST FOR ACID TREATMENT OF BRASS							
4" SQUARE, DECK MOUNT BASE, 30" BOLLARD, 4 WINDOW, FLAT TOP, STAINLESS STEEL U-BRACKET, 120V							
PL23LGS4WDM30L108BLT	ALUMINUM	BLACK TEXTURE	3W MR16 LED 36°	3000K/270LM	GU10	\$412.50	
PL23LGS4WDM30L108BRS	BRASS	UNFINISHED	3W MR16 LED 36°	3000K/270LM	GU10	\$795.30	
30" FIXTURE ADD ON COST FOR ACID TREATMENT OF BRASS							
4" SQUARE, DECK MOUNT BASE, 36" BOLLARD, 4 WINDOW, FLAT TOP, STAINLESS STEEL U-BRACKET, 12V							
PL23LGS4WDM36L24BLT	ALUMINUM	BLACK TEXTURE	3W MR16 LED 36°	3000K/270LM	GU5.3	\$425.70	
PL23LGS4WDM36L24BRS	BRASS	UNFINISHED	3W MR16 LED 36°	3000K/270LM	GU5.3	\$869.00	
36" FIXTURE ADD ON COST FOR ACID TREATMENT OF BRASS							
4" SQUARE, DECK MOUNT BASE, 36" BOLLARD, 4 WINDOW, FLAT TOP, STAINLESS STEEL U-BRACKET, 120V							
PL23LGS4WDM36L108BLT	ALUMINUM	BLACK TEXTURE	3W MR16 LED 36°	3000K/270LM	GU10	\$440.00	
PL23LGS4WDM36L108BRS	BRASS	UNFINISHED	3W MR16 LED 36°	3000K/270LM	GU10	\$883.30	
36" FIXTURE ADD ON COST FOR ACID TREATMENT OF BRASS							

FINISHES: (SEE PAGE 49 FOR MORE INFORMATION)

ADD ON COST FOR OPTIONAL FINISHES	\$22.00
ADD ON COST FOR PREMIUM COLOR BKM	\$39.60
ADD ON COST FOR PREMIUM COLOR DBZ	\$35.20

*NOTE: CUSTOM PRODUCT CONFIGURATIONS, PAINT FINISHES, AND ACID TREATMENTS ARE AVAILABLE; BUT NON RETURNABLE

OPTIONAL MOUNTING DEVICES:

FA033PBLK - 3 PRONG STAKE. STAINLESS STEEL, 1/2" NPS FEMALE THREADED. BLACK	\$56.25
FAJBOX - CAST BRASS JUNCTION BOX, 1/2" NPS FEMALE THREADED ON COVER	\$198.00
FA25BLT - 12V PVC MOUNTING PEDESTAL. ALUMINUM CAP. BLACK TEXTURE	\$55.00
FA25BRS - 12V PVC MOUNTING PEDESTAL. BRASS CAP.	\$75.90
FA26BLT - 120V PVC MOUNTING PEDESTAL. ALUMINUM CAP. BLACK TEXTURE	\$56.10
FA26BRS - 120V PVC MOUNTING PEDESTAL. BRASS CAP	\$79.20
*NOTE: TO USE ANY OF THE ABOVE LISTED MOUNTING DEVICES, ADD FA1218 REDUCER	\$8.80

12V-277V PL26	CUSTOM SQUARE BOLLARD	MATERIAL	FINISH	LED	CCT/LM	SOCKET	CURRENT LIST PRICE USD\$
------------------	-----------------------	----------	--------	-----	--------	--------	-----------------------------

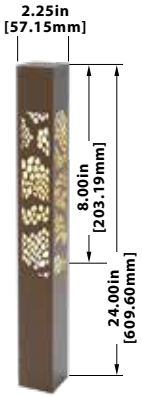

2.25" SQUARE X 24" DECK MOUNT, CUSTOM DESIGN, FA03LG MOUNTING STAKE (SHOWN)							
PL26DMCD001L24BLT	ALUMINUM	BLACK TEXTURE	3W MR16 LED 36°	3000K/270LM	GU5.3	\$236.50	
PL26DMCD001L24BRS	BRASS	UNFINISHED	3W MR16 LED 36°	3000K/270LM	GU5.3	\$401.50	

FINISHES: (SEE PAGE 49 FOR MORE INFORMATION)							
ADD ON COST FOR OPTIONAL FINISHES						\$11.00	
ADD ON COST FOR PREMIUM COLOR BKM						\$19.80	
ADD ON COST FOR PREMIUM COLOR DBZ						\$17.60	
ADD ON COST FOR ACID TREATMENT OF BRASS						\$48.00	

ALL POWDER COAT FINISHES OVER BRASS ARE CUSTOM AND NON RETURNABLE							
120V OPTION: (SEE PAGE 51 FOR MORE INFORMATION)							
CHANGE TO GU10 SOCKET - FOR LAMPS: L106, L108, L110, L114, L116, L118, L124, L128						\$11.00	



POWER SUPPLY:							
120V-277V USES P/N HW1260LED277R1 TRANSFORMER INSTALLED IN WEATHERPROOF JUNCTION BOX NO MORE THAN 18' FROM FIXTURE						\$99.00	



12V-277V PL26LG	CUSTOM SQUARE BOLLARD	MATERIAL	FINISH	LED	CCT/LM	SOCKET	CURRENT LIST PRICE USD\$
--------------------	-----------------------	----------	--------	-----	--------	--------	-----------------------------

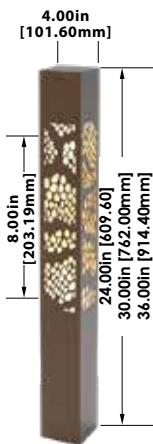

4" SQUARE X 24" ALUMINUM DECK MOUNT, CUSTOM DESIGN, STAINLESS STEEL U-BRACKET (SHOWN)							
PL26LGDMCD001L24BLT	ALUMINUM	BLACK TEXTURE	3W MR16 LED 36°	3000K/270LM	GU5.3	\$469.70	

4" SQUARE X 24" BRASS DECK MOUNT, CUSTOM DESIGN, STAINLESS STEEL U-BRACKET							
PL26LGDMCD001L24BRS	BRASS	UNFINISHED	3W MR16 LED 36°	3000K/270LM	GU5.3	\$858.00	

4" SQUARE X 30" BRASS DECK MOUNT, CUSTOM DESIGN, STAINLESS STEEL U-BRACKET							
PL26LGDMCD00130L24BRS	BRASS	UNFINISHED	3W MR16 LED 36°	3000K/270LM	GU5.3	\$907.50	

4" SQUARE X 30" ALUMINUM DECK MOUNT, CUSTOM DESIGN, STAINLESS STEEL U-BRACKET							
PL26LGDMCD00130L24BLT	ALUMINUM	BLACK TEXTURE	3W MR16 LED 36°	3000K/270LM	GU5.3	\$491.70	

4" SQUARE X 36" ALUMINUM DECK MOUNT, CUSTOM DESIGN, STAINLESS STEEL U-BRACKET							
PL26LGDMCS00136L24BLT	ALUMINUM	BLACK TEXTURE	3W MR16 LED 36°	3000K/270LM	GU5.3	\$513.70	

4" SQUARE X 36" BRASS DECK MOUNT, CUSTOM DESIGN, STAINLESS STEEL U-BRACKET							
PL26LGDMCS00136L24BRS	BRASS	UNFINISHED	3W MR16 LED 36°	3000K/270LM	GU5.3	\$968.00	

FINISHES: (SEE PAGE 49 FOR MORE INFORMATION)							
ADD ON COST FOR OPTIONAL FINISHES						\$22.00	
ADD ON COST FOR PREMIUM COLOR BKM						\$39.60	
ADD ON COST FOR PREMIUM COLOR DBZ						\$35.20	
ADD ON COST FOR ACID TREATMENT OF BRASS						\$48.00	

*NOTE: CUSTOM PRODUCT CONFIGURATIONS, PAINT FINISHES, AND ACID TREATMENTS ARE AVAILABLE; BUT NON RETURNABLE							
120V OPTION: (SEE PAGE 51 FOR MORE INFORMATION)							
CHANGE TO GU10 SOCKET - FOR LAMPS: L106, L108, L110, L114, L116, L118, L124, L128						\$11.00	



POWER SUPPLY:							
120V-277V USES P/N HW1260LED277R1 TRANSFORMER INSTALLED IN WEATHERPROOF JUNCTION BOX NO MORE THAN 18' FROM FIXTURE						\$99.00	

12V-277V PL26AB	SQUARE BOLLARD	MATERIAL	FINISH	LED	CCT/LM	SOCKET	CURRENT LIST PRICE USD\$
--------------------	----------------	----------	--------	-----	--------	--------	-----------------------------

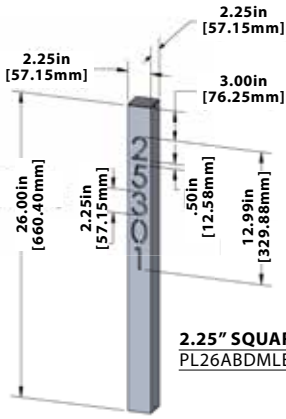

2.25" SQUARE X 26" ALUMINUM DECK MOUNT, 1 SIDE NUMBERING, FA03LG MOUNTING STAKE (SHOWN)

PL26ABDMLDS812VBLT	ALUMINUM	BLACK TEXTURE	2X 4W LED STRIP	3000K/630LM	NONE	\$291.50
--------------------	----------	---------------	-----------------	-------------	------	----------

2.25" SQUARE X 26" BRASS DECK MOUNT, 1 SIDE NUMBERING, FA03LG MOUNTING STAKE

PL26ABDMLDS812VBRS	BRASS	UNFINISHED	2X 4W LED STRIP	3000K/630LM	NONE	\$484.00
--------------------	-------	------------	-----------------	-------------	------	----------

*NOTE: CUSTOM PRODUCT CONFIGURATIONS, PAINT FINISHES, AND ACID TREATMENTS ARE AVAILABLE; BUT NON RETURNABLE

FINISHES: (SEE PAGE 49 FOR MORE INFORMATION)

ADD ON COST FOR OPTIONAL FINISHES	\$11.00
ADD ON COST FOR PREMIUM COLOR BKM	\$19.80
ADD ON COST FOR PREMIUM COLOR DBZ	\$17.60
ADD ON COST FOR ACID TREATMENT OF BRASS	\$33.00

*NOTE: CUSTOM PRODUCT CONFIGURATIONS, PAINT FINISHES, AND ACID TREATMENTS ARE AVAILABLE; BUT NON RETURNABLE

12V-277V PL26LGAB	SQUARE BOLLARD	MATERIAL	FINISH	LED	CCT/LM	SOCKET	CURRENT LIST PRICE USD\$
----------------------	----------------	----------	--------	-----	--------	--------	-----------------------------

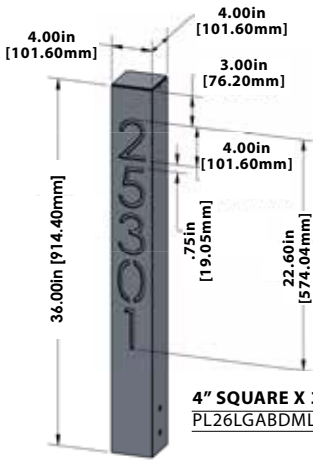

4" SQUARE X 36" ALUMINUM DECK MOUNT, 1 SIDE NUMBERING, FA03LG MOUNTING STAKE (SHOWN)

PL26LGABDMLDS812VBLT	ALUMINUM	BLACK TEXTURE	2X 4W LED STRIP	3000K/630LM	NONE	\$418.00
----------------------	----------	---------------	-----------------	-------------	------	----------

4" SQUARE X 36" BRASS DECK MOUNT, 1 SIDE NUMBERING, FA03LG MOUNTING STAKE

PL26LGABDMLDS812VBRS	BRASS	UNFINISHED	2X 4W LED STRIP	3000K/630LM	NONE	\$814.00
----------------------	-------	------------	-----------------	-------------	------	----------

*NOTE: CUSTOM PRODUCT CONFIGURATIONS, PAINT FINISHES, AND ACID TREATMENTS ARE AVAILABLE; BUT NON RETURNABLE

FINISHES: (SEE PAGE 49 FOR MORE INFORMATION)

ADD ON COST FOR OPTIONAL FINISHES	\$22.00
ADD ON COST FOR PREMIUM COLOR BKM	\$39.60
ADD ON COST FOR PREMIUM COLOR DBZ	\$35.20
ADD ON COST FOR ACID TREATMENT OF BRASS	\$48.00

*NOTE: CUSTOM PRODUCT CONFIGURATIONS, PAINT FINISHES, AND ACID TREATMENTS ARE AVAILABLE; BUT NON RETURNABLE

OPTIONAL MOUNTING DEVICES:

FA033PBLK - 3 PRONG STAKE. STAINLESS STEEL, 1/2" NPS FEMALE THREADED. BLACK	\$56.25
FAJBOX - CAST BRASS JUNCTION BOX, 1/2" NPS FEMALE THREADED ON COVER	\$198.00
FA25BLT - 12V PVC MOUNTING PEDESTAL. ALUMINUM CAP. BLACK TEXTURE	\$55.00
FA25BRS - 12V PVC MOUNTING PEDESTAL. BRASS CAP.	\$75.90
FA26BLT - 120V PVC MOUNTING PEDESTAL. ALUMINUM CAP. BLACK TEXTURE	\$56.10
FA26BRS - 120V PVC MOUNTING PEDESTAL. BRASS CAP	\$79.20
*NOTE: TO USE ANY OF THE ABOVE LISTED MOUNTING DEVICES, ADD FA1218 REDUCER	\$8.80

*NOTE: CUSTOM HEIGHTS AVAILABLE. CONSULT FACTORY FOR MORE DETAILS

Specialty Lights



TO PLACE ORDERS
 ORDERS@FOCUSINDUSTRIES.COM
 TOLL FREE (888)882.1350

MORE INFORMATION ON FOCUS PRODUCTS
 DOWNLOAD OUR BROCHURES
 WWW.FOCUSINDUSTRIES.COM

*Prices subject to change. Consult factory for pricing, questions or inquiries.

12V SL37BL	BOCCE	MATERIAL	FINISH	LED	CCT/LM	SOCKET	CURRENT LIST PRICE USD\$
---------------	-------	----------	--------	-----	--------	--------	--------------------------

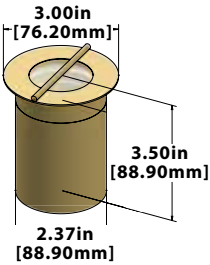

CIRCULAR DROP IN PAVER LIGHT WITH SINGLE GRATE, BOCCE BALL COURT LIGHT

SL37BLL22BRS	BRASS	UNFINISHED	3W MR16 LED 15°	3000K/270LM	GU5.3	\$167.20
SL37BLL34BRS	BRASS	UNFINISHED	5W MR16 LED 15°	3000K/450LM	GU5.3	\$168.30
SL37BLL46BRS	BRASS	UNFINISHED	7W MR16 LED 15°	3000K/550LM	GU5.3	\$170.50

FINISHES: (SEE PAGE 49 FOR MORE INFORMATION)

ADD ON COST FOR OPTIONAL COLOR FINISHES	\$11.00
ADD ON COST FOR PREMIUM COLOR BKM	\$19.80
ADD ON COST FOR PREMIUM COLOR DBZ	\$17.60
ADD ON COST FOR ACID TREATMENT OF BRASS	\$33.00

*NOTE: CUSTOM PRODUCT CONFIGURATIONS, PAINT FINISHES, AND ACID TREATMENTS ARE AVAILABLE; BUT NON RETURNABLE

COLOR GLASS LENS OPTIONS:

FA1017AMBER - AMBER TEMPERED GLASS LENS 1.4" OD X 0.125" ± 0.03"TH	\$22.28
FA1017RED - RED TEMPERED GLASS LENS 1.4" OD X 0.125" ± 0.03"TH	\$22.28
FA1017BLUE - BLUE TEMPERED GLASS LENS 1.4" OD X 0.125" ± 0.03"TH	\$22.28
FA1017GREEN - GREEN TEMPERED GLASS LENS 1.4" OD X 0.125" ± 0.03"TH	\$22.28

TO HAVE COLOR LENS INSTALLED ADD: (A) FOR AMBER (R) FOR RED (B) FOR BLUE (G) FOR GREEN, TO PART NUMBER AND ADD \$22.28 TO FIXTURE PRICE

*NOTE: CUSTOM PRODUCT CONFIGURATIONS, PAINT FINISHES, AND ACID TREATMENTS ARE AVAILABLE; BUT NON RETURNABLE

Step / Brick Lights



*Prices subject to change. Consult factory for pricing, questions or inquiries.

12V-277V SL62LEDM	STEP LIGHT	MATERIAL	FINISH	LED	CCT/LM	SOCKET	CURRENT LIST PRICE USD\$
----------------------	------------	----------	--------	-----	--------	--------	--------------------------

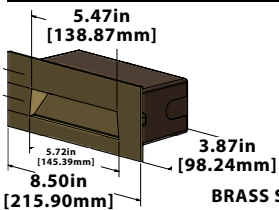

BRASS STEP/BRICK LIGHT, 12V

SL62LEDMBRS	BRASS	UNFINISHED	2X 3W LED MODULE	2800K/570LM	NONE	\$167.20
-------------	-------	------------	------------------	-------------	------	----------

BRASS STEP/BRICK LIGHT, 120V

SL62LEDM120BRS	BRASS	UNFINISHED	2X 3W LED MODULE	2800K/570LM	NONE	\$254.10
----------------	-------	------------	------------------	-------------	------	----------

BRASS STEP/BRICK LIGHT, 277V

SL62LEDM277BRS	BRASS	UNFINISHED	2X 3W LED MODULE	2800K/570LM	NONE	\$368.50
----------------	-------	------------	------------------	-------------	------	----------

FINISHES: (SEE PAGE 49 FOR MORE INFORMATION)

ADD ON COST FOR OPTIONAL COLOR FINISHES	\$11.00
ADD ON COST FOR PREMIUM COLOR BKM	\$19.80
ADD ON COST FOR PREMIUM COLOR DBZ	\$17.60
ADD ON COST FOR ACID TREATMENT OF COPPER	\$33.00

*NOTE: CUSTOM PRODUCT CONFIGURATIONS, PAINT FINISHES, AND ACID TREATMENTS ARE AVAILABLE; BUT NON RETURNABLE

Surface Mounts



TO PLACE ORDERS
 ORDERS@FOCUSINDUSTRIES.COM
 TOLL FREE (888)882.1350

MORE INFORMATION ON FOCUS PRODUCTS
 DOWNLOAD OUR BROCHURES
 WWW.FOCUSINDUSTRIES.COM

*Prices subject to change. Consult factory for pricing, questions or inquiries.

120V-277V RXS10SMFP	SURFACE MOUNT	MATERIAL	FINISH	LED	CCT/LM	SOCKET	CURRENT LIST PRICE USD\$
------------------------	---------------	----------	--------	-----	--------	--------	--------------------------

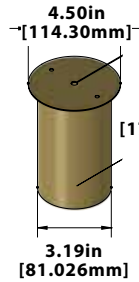

3.19" DIA X 6.81" BRASS CYLINDER SURFACE MOUNT, 4.5" FLAT PLATE MOUNT, PAR20 120V-277V (SHOWN)

RXS10SMFPL140BRS	BRASS	UNFINISHED	8W PAR20 LED 15°	3000K/720LM	MEDIUM BASE	\$255.20
RXS10SMFPL142BRS	BRASS	UNFINISHED	8W PAR20 LED 40°	3000K/720LM	MEDIUM BASE	\$255.20

FINISHES: (SEE PAGE 49 FOR MORE INFORMATION)

ADD ON COST FOR OPTIONAL FINISHES	\$11.00
ADD ON COST FOR PREMIUM COLOR BKM	\$19.80
ADD ON COST FOR PREMIUM COLOR DBZ	\$17.60
ADD ON COST FOR ACID TREATMENT OF BRASS	\$33.00

*NOTE: CUSTOM PRODUCT CONFIGURATIONS, PAINT FINISHES, AND ACID TREATMENTS ARE AVAILABLE; BUT NON RETURNABLE

120V-277V RXS10SM24	SURFACE MOUNT	MATERIAL	FINISH	LED	CCT/LM	SOCKET	CURRENT LIST PRICE USD\$
------------------------	---------------	----------	--------	-----	--------	--------	--------------------------

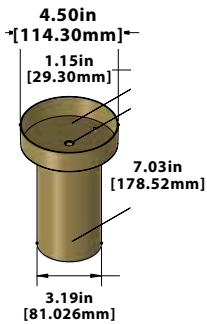

3.19" DIA X 7.03" BRASS CYLINDER SURFACE MOUNT, 4.5" CANOPY MOUNT, PAR20 120V-277V (SHOWN)

RXS10SM24L140BRS	BRASS	UNFINISHED	8W PAR20 LED 15°	3000K/720LM	MEDIUM BASE	\$290.60
RXS10SM24L142BRS	BRASS	UNFINISHED	8W PAR20 LED 40°	3000K/720LM	MEDIUM BASE	\$290.60

FINISHES: (SEE PAGE 49 FOR MORE INFORMATION)

ADD ON COST FOR OPTIONAL FINISHES	\$11.00
ADD ON COST FOR PREMIUM COLOR BKM	\$19.80
ADD ON COST FOR PREMIUM COLOR DBZ	\$17.60
ADD ON COST FOR ACID TREATMENT OF BRASS	\$33.00

*NOTE: CUSTOM PRODUCT CONFIGURATIONS, PAINT FINISHES, AND ACID TREATMENTS ARE AVAILABLE; BUT NON RETURNABLE

12V-277V RXS12SM	SURFACE MOUNT	MATERIAL	FINISH	LED	CCT/LM	SOCKET	CURRENT LIST PRICE USD\$
---------------------	---------------	----------	--------	-----	--------	--------	--------------------------

	2.37" DIA X 4.88" BRASS CYLINDER SURFACE MOUNT, 3" CANOPY MOUNT, 12V (SHOWN)						
	RXS12SML24BRS	BRASS	UNFINISHED	3W MR16 SS LED 36°	3000K/270LM	GU5.3	\$159.50
	2.37" DIA X 4.88" BRASS CYLINDER SURFACE MOUNT, 4.5" FLAT PLATE MOUNT, 12V-277V						
	RXS12SMFPL24BRS	BRASS	UNFINISHED	3W MR16 SS LED 36°	3000K/270LM	GU5.3	\$181.50
	RXS12SMFPL108BRS	BRASS	UNFINISHED	3W MR16 SS LED 36°	3000K/270LM	GU10	\$195.80
	2.37" DIA X 4.88" BRASS CYLINDER SURFACE MOUNT, 4.5" CANOPY MOUNT, 12V-277V						
RXS12SM24L24BRS	BRASS	UNFINISHED	3W MR16 SS LED 36°	3000K/270LM	GU5.3	\$203.50	
RXS12SM24L108BRS	BRASS	UNFINISHED	3W MR16 SS LED 36°	3000K/270LM	GU10	\$217.80	

FINISHES: (SEE PAGE 49 FOR MORE INFORMATION)

ADD ON COST FOR OPTIONAL FINISHES	\$11.00
ADD ON COST FOR PREMIUM COLOR BKM	\$19.80
ADD ON COST FOR PREMIUM COLOR DBZ	\$17.60
ADD ON COST FOR ACID TREATMENT OF BRASS	\$33.00

*NOTE: CUSTOM PRODUCT CONFIGURATIONS, PAINT FINISHES, AND ACID TREATMENTS ARE AVAILABLE; BUT NON RETURNABLE

120V OPTION: (SEE PAGE 51 FOR MORE INFORMATION)

CHANGE TO GU10 SOCKET	FOR LAMPS: L106, L108, L110, L114, L116, L118, L124, L128	\$11.00
-----------------------	---	---------



POWER SUPPLY:

120V-277V USES P/N HW1260LED277R1 TRANSFORMER INSTALLED IN WEATHERPROOF JUNCTION BOX NO MORE THAN 18' FROM FIXTURE	\$99.00
--	---------

12V-277V RXS18LEDM	SURFACE MOUNT	MATERIAL	FINISH	LED	CCT/LM	SOCKET	CURRENT LIST PRICE USD\$
-----------------------	---------------	----------	--------	-----	--------	--------	--------------------------

3.18" DIA X 4.74" BRASS CYLINDER SURFACE MOUNT, 4.5" CANOPY MOUNT, 12V (SHOWN)

RXS18SM24LEDM715BRS	BRASS	UNFINISHED	7W LED MODULE 15°	2800K/450LM	NONE	\$357.50
RXS18SM24LEDM740BRS	BRASS	UNFINISHED	7W LED MODULE 40°	2800K/450LM	NONE	\$357.50
RXS18SM24LEDM760BRS	BRASS	UNFINISHED	7W LED MODULE 60°	2800K/450LM	NONE	\$357.50
RXS18SM24LEDM7WFBRS	BRASS	UNFINISHED	7W WIDE FLOOD	2800K/450LM	NONE	\$335.50

FINISHES: (SEE PAGE 49 FOR MORE INFORMATION)

ADD ON COST FOR OPTIONAL FINISHES	\$11.00
ADD ON COST FOR PREMIUM COLOR BKM	\$19.80
ADD ON COST FOR PREMIUM COLOR DBZ	\$17.60
ADD ON COST FOR ACID TREATMENT OF BRASS	\$33.00

*NOTE: CUSTOM PRODUCT CONFIGURATIONS, PAINT FINISHES, AND ACID TREATMENTS ARE AVAILABLE; BUT NON RETURNABLE



POWER SUPPLY:

120V-277V USES P/N HW1260LED277R1 TRANSFORMER INSTALLED IN WEATHERPROOF JUNCTION BOX NO MORE THAN 18' FROM FIXTURE	\$99.00
--	---------

120V-277V RXS10SMFP	SURFACE MOUNT	MATERIAL	FINISH	LED	CCT/LM	SOCKET	CURRENT LIST PRICE USD\$
------------------------	---------------	----------	--------	-----	--------	--------	-----------------------------

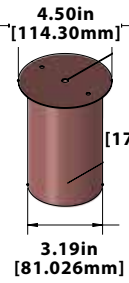

3.19" DIA X 6.81" COPPER CYLINDER SURFACE MOUNT 4.5" FLAT PLATE MOUNT, PAR20 120V-277V (SHOWN)							
RXS10SMFPL140COP	COPPER	UNFINISHED	8W PAR20 LED 15°	3000K/720LM	MEDIUM BASE	\$333.50	
RXS10SMFPL142COP	COPPER	UNFINISHED	8W PAR20 LED 40°	3000K/720LM	MEDIUM BASE	\$333.50	

FINISHES: (SEE PAGE 49 FOR MORE INFORMATION)							
ADD ON COST FOR OPTIONAL FINISHES						\$11.00	
ADD ON COST FOR PREMIUM COLOR BKM						\$19.80	
ADD ON COST FOR PREMIUM COLOR DBZ						\$17.60	
ADD ON COST FOR ACID TREATMENT OF COPPER						\$33.00	
*NOTE: CUSTOM PRODUCT CONFIGURATIONS, PAINT FINISHES, AND ACID TREATMENTS ARE AVAILABLE; BUT NON RETURNABLE							

120V-277VV RXS10SM24	SURFACE MOUNT	MATERIAL	FINISH	LED	CCT/LM	SOCKET	CURRENT LIST PRICE USD\$
-------------------------	---------------	----------	--------	-----	--------	--------	-----------------------------



3.19" DIA X 7.03" COPPER CYLINDER SURFACE MOUNT, 4.5" CANOPY MOUNT, PAR20 120V-277V (SHOWN)							
RXS10SM24L140COP	COPPER	UNFINISHED	8W PAR20 LED 15°	3000K/720LM	MEDIUM BASE	\$353.10	
RXS10SM24L142COP	COPPER	UNFINISHED	8W PAR20 LED 40°	3000K/720LM	MEDIUM BASE	\$353.10	

FINISHES: (SEE PAGE 49 FOR MORE INFORMATION)							
ADD ON COST FOR OPTIONAL FINISHES						\$11.00	
ADD ON COST FOR PREMIUM COLOR BKM						\$19.80	
ADD ON COST FOR PREMIUM COLOR DBZ						\$17.60	
ADD ON COST FOR ACID TREATMENT OF COPPER						\$33.00	
*NOTE: CUSTOM PRODUCT CONFIGURATIONS, PAINT FINISHES, AND ACID TREATMENTS ARE AVAILABLE; BUT NON RETURNABLE							

12V-277V RXS12SM	SURFACE MOUNT	MATERIAL	FINISH	LED	CCT/LM	SOCKET	CURRENT LIST PRICE USD\$
---------------------	---------------	----------	--------	-----	--------	--------	-----------------------------

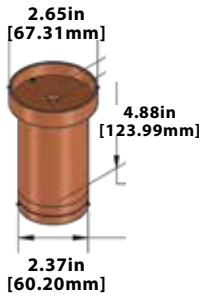

2.37" DIA X 4.88" COPPER CYLINDER SURFACE MOUNT, 2.65" CANOPY MOUNT, 12V-120V (SHOWN)							
RXS12SML24COP		COPPER	UNFINISHED	3W MR16 SS LED 36°	3000K/270LM	GU5.3	\$160.60
2.37" DIA X 4.88" COPPER CYLINDER SURFACE MOUNT, 4.5" FLAT PLATE MOUNT, 12V-120V							
RXS12SMFPL24COP		SCOPPER	UNFINISHED	3W MR16 SS LED 36°	3000K/270LM	GU5.3	\$179.30
2.37" DIA X 4.88" COPPER CYLINDER SURFACE MOUNT, 4.5" CANOPY MOUNT, 12V-120V							
RXS12SM24L24COP		COPPER	UNFINISHED	3W MR16 SS LED 36°	3000K/270LM	GU5.3	\$196.90
RXS12SM24L108COP		COPPER	UNFINISHED	3W MR16 SS LED 36°	3000K/270LM	GU10	\$211.20
FINISHES: (SEE PAGE 49 FOR MORE INFORMATION)							
ADD ON COST FOR OPTIONAL FINISHES							\$11.00
ADD ON COST FOR PREMIUM COLOR BKM							\$19.80
ADD ON COST FOR PREMIUM COLOR DBZ							\$17.60
ADD ON COST FOR ACID TREATMENT OF COPPER							\$33.00
*NOTE: CUSTOM PRODUCT CONFIGURATIONS, PAINT FINISHES, AND ACID TREATMENTS ARE AVAILABLE; BUT NON RETURNABLE							
120V OPTION: (SEE PAGE 51 FOR MORE INFORMATION)							
CHANGE TO GU10 SOCKET - FOR LAMPS: L106, L108, L110, L114, L116, L118, L124, L128							\$11.00



POWER SUPPLY:							
120V-120V-277V USES P/N HW1260LED277R1 TRANSFORMER INSTALLED IN WEATHERPROOF JUNCTION BOX NO MORE THAN 18' FROM FIXTURE							\$99.00

12V-277V RXS18LEDM	SURFACE MOUNT	MATERIAL	FINISH	LED	CCT/LM	SOCKET	CURRENT LIST PRICE USD\$
-----------------------	---------------	----------	--------	-----	--------	--------	-----------------------------

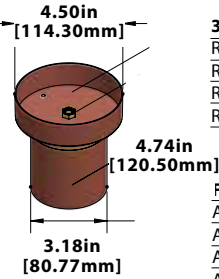

3.18" DIA X 4.74" COPPER CYLINDER SURFACE MOUNT, 4.5" CANOPY MOUNT, 12V (SHOWN)							
RXS18SM24LEDM715COP		COPPER	UNFINISHED	7W LED MODULE 15°	2800K/450LM	NONE	\$357.50
RXS18SM24LEDM740COP		COPPER	UNFINISHED	7W LED MODULE 40°	2800K/450LM	NONE	\$357.50
RXS18SM24LEDM760COP		COPPER	UNFINISHED	7W LED MODULE 60°	2800K/450LM	NONE	\$357.50
RXS18SM24LEDM7WFCOP		COPPER	UNFINISHED	7W WIDE FLOOD	2800K/450LM	NONE	\$335.50
FINISHES: (SEE PAGE 49 FOR MORE INFORMATION)							
ADD ON COST FOR OPTIONAL FINISHES							\$11.00
ADD ON COST FOR PREMIUM COLOR BKM							\$19.80
ADD ON COST FOR PREMIUM COLOR DBZ							\$17.60
ADD ON COST FOR ACID TREATMENT OF COPPER							\$33.00
*NOTE: CUSTOM PRODUCT CONFIGURATIONS, PAINT FINISHES, AND ACID TREATMENTS ARE AVAILABLE; BUT NON RETURNABLE							



POWER SUPPLY:							
120V-277V USES P/N HW1260LED277R1 TRANSFORMER INSTALLED IN WEATHERPROOF JUNCTION BOX NO MORE THAN 18' FROM FIXTURE							\$99.00

12V-277V RXS12SMFP	SURFACE MOUNT	MATERIAL	FINISH	LED	CCT/LM	SOCKET	CURRENT LIST PRICE USD\$
-----------------------	---------------	----------	--------	-----	--------	--------	-----------------------------

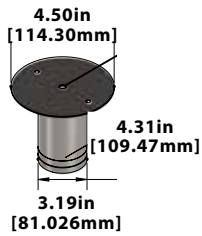

3.19" DIA X 4.31" STAINLESS STEEL CYLINDER SURFACE MOUNT, 4.5" FLAT PLATE, 12V (SHOWN)							
RXS12SMFPL24SS		STAINLESS STEEL	UNFINISHED	3W MR16 SS LED 36°	3000K/270LM	GU5.3	\$212.50

3.19" DIA X 4.31" STAINLESS STEEL CYLINDER SURFACE MOUNT, 4.5" FLAT PLATE, 120V							
RXS12SMFPL108SS		STAINLESS STEEL	UNFINISHED	3W MR16 SS LED 36°	3000K/270LM	GU10	\$226.80

FINISHES: (SEE PAGE 49 FOR MORE INFORMATION)							
ADD ON COST FOR OPTIONAL FINISHES							\$11.00
ADD ON COST FOR PREMIUM COLOR BKM							\$19.80
ADD ON COST FOR PREMIUM COLOR DBZ							\$17.60
*NOTE: CUSTOM PRODUCT CONFIGURATIONS, PAINT FINISHES, AND ACID TREATMENTS ARE AVAILABLE; BUT NON RETURNABLE							

120V OPTION: (SEE PAGE 51 FOR MORE INFORMATION)							
CHANGE TO GU10 SOCKET - FOR LAMPS: L106, L108, L110, L114, L116, L118, L124, L128							\$11.00



POWER SUPPLY:							
120V-277V USES P/N HW1260LED277R1 TRANSFORMER INSTALLED IN CANOPY OR BEHIND FLAT PLATE IN J-BOX							\$99.00

12V-277V RXS12SM	SURFACE MOUNT	MATERIAL	FINISH	LED	CCT/LM	SOCKET	CURRENT LIST PRICE USD\$
---------------------	---------------	----------	--------	-----	--------	--------	-----------------------------

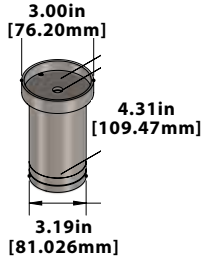

3.19" DIA X 4.31" STAINLESS STEEL CYLINDER SURFACE MOUNT, 3" CANOPY MOUNT, 12V							
RXS12SML24SS		STAINLESS STEEL	UNFINISHED	3W MR16 SS LED 36°	3000K/270LM	GU5.3	\$206.25

FINISHES: (SEE PAGE 49 FOR MORE INFORMATION)							
ADD ON COST FOR OPTIONAL FINISHES							\$11.00
ADD ON COST FOR PREMIUM COLOR BKM							\$19.80
ADD ON COST FOR PREMIUM COLOR DBZ							\$17.60
*NOTE: CUSTOM PRODUCT CONFIGURATIONS, PAINT FINISHES, AND ACID TREATMENTS ARE AVAILABLE; BUT NON RETURNABLE							



POWER SUPPLY							
120V-277V USES P/N HW1260LED277R1 TRANSFORMER INSTALLED IN CANOPY OR BEHIND FLAT PLATE IN J-BOX							\$99.00

12V-277V RXS12SM24	SURFACE MOUNT	MATERIAL	FINISH	LED	CCT/LM	SOCKET	CURRENT LIST PRICE USD\$
-----------------------	---------------	----------	--------	-----	--------	--------	-----------------------------

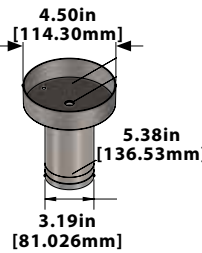

3.19" DIA X 5.38" STAINLESS STEEL CYLINDER SURFACE MOUNT, 4.5" CANOPY MOUNT, 12V							
RXS12SM24L24SS		STAINLESS STEEL	UNFINISHED	3W MR16 SS LED 36°	3000K/270LM	GU5.3	\$245.00

3.19" DIA X 5.38" STAINLESS STEEL CYLINDER SURFACE MOUNT, 4.5" CANOPY MOUNT, 120V							
RXS12SM24L108SS		STAINLESS STEEL	UNFINISHED	3W MR16 SS LED 36°	3000K/270LM	GU10	\$259.30

FINISHES: (SEE PAGE 49 FOR MORE INFORMATION)							
ADD ON COST FOR OPTIONAL FINISHES							\$11.00
ADD ON COST FOR PREMIUM COLOR BKM							\$19.80
ADD ON COST FOR PREMIUM COLOR DBZ							\$17.60
*NOTE: CUSTOM PRODUCT CONFIGURATIONS, PAINT FINISHES, AND ACID TREATMENTS ARE AVAILABLE; BUT NON RETURNABLE							

120V OPTION: (SEE PAGE 51 FOR MORE INFORMATION)							
CHANGE TO GU10 SOCKET - FOR LAMPS: L106, L108, L110, L114, L116, L118, L124, L128							\$11.00



POWER SUPPLY:							
120V-277V USES P/N HW1260LED277R1 TRANSFORMER INSTALLED IN WEATHERPROOF JUNCTION BOX NO MORE THAN 18' FROM FIXTURE							\$99.00

Surface Mounts



TO PLACE ORDERS
ORDERS@FOCUSINDUSTRIES.COM
TOLL FREE (888)882.1350

MORE INFORMATION ON FOCUS PRODUCTS
DOWNLOAD OUR BROCHURES
WWW.FOCUSINDUSTRIES.COM

*Prices subject to change. Consult factory for pricing, questions or inquiries.

12V-277V	WALL MOUNT	MATERIAL	FINISH	LED	CCT/LM	SOCKET	CURRENT LIST PRICE USD\$
----------	------------	----------	--------	-----	--------	--------	--------------------------

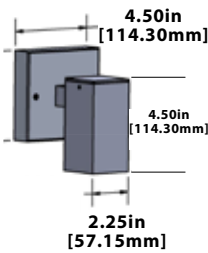

2" X 2" ALUMINUM WALL MOUNT, DOWN LIGHT, 4.5" SQUARE CANOPY, 12V (SHOWN)							
SL63WMDL24BLT	ALUMINUM	BLACK TEXTURE	3W MR16 SS LED 36°	3000K/270LM	GU5.3	\$134.20	
SL63WMDNLBLT	ALUMINUM	BLACK TEXTURE	NO LAMP		GU5.3	\$104.50	

2" X 2" ALUMINUM WALL MOUNT, DOWN LIGHT, 4.5" SQUARE CANOPY, 120V							
SL63WMDL108BLT	ALUMINUM	BLACK TEXTURE	3W MR16 SS LED 36°	3000K/270LM	GU10	\$148.50	
SL63WMDGU10NLBLT	ALUMINUM	BLACK TEXTURE	NO LAMP		GU10	\$115.50	

2" X 2" BRASS WALL MOUNT, DOWN LIGHT, 4.5" SQUARE CANOPY, 12V							
SL63WMDL24BRS	BRASS	UNFINISHED	3W MR16 SS LED 36°	3000K/270LM	GU5.3	\$255.20	
SL63WMDNLRBS	BRASS	UNFINISHED	NO LAMP		GU5.3	\$225.50	

2" X 2" BRASS WALL MOUNT, DOWN LIGHT, 4.5" SQUARE CANOPY, 120V							
SL63WMDL108BRS	BRASS	UNFINISHED	3W MR16 SS LED 36°	3000K/270LM	GU10	\$269.50	
SL63WMDGU10NLRBS	BRASS	UNFINISHED	NO LAMP		GU10	\$236.50	

FINISHES: (SEE PAGE 49 FOR MORE INFORMATION)							
ADD ON COST FOR OPTIONAL FINISHES						\$11.00	
ADD ON COST FOR PREMIUM COLOR BKM						\$19.80	
ADD ON COST FOR PREMIUM COLOR DBZ						\$17.60	
ADD ON COST FOR ACID TREATMENT OF BRASS						\$33.00	

*NOTE: CUSTOM PRODUCT CONFIGURATIONS, PAINT FINISHES, AND ACID TREATMENTS ARE AVAILABLE; BUT NON RETURNABLE

120V OPTION: (SEE PAGE 51 FOR MORE INFORMATION)							
CHANGE TO GU10 SOCKET - FOR LAMPS: L106, L108, L110, L114, L116, L118, L124, L128						\$11.00	



POWER SUPPLY:							
120V-277V USES P/N HW1260LED277R1 TRANSFORMER INSTALLED IN WEATHERPROOF JUNCTION BOX NO MORE THAN 18' FROM FIXTURE						\$99.00	

12V-277V	WALL MOUNT	MATERIAL	FINISH	LED	CCT/LM	SOCKET	CURRENT LIST PRICE USD\$
----------	------------	----------	--------	-----	--------	--------	--------------------------

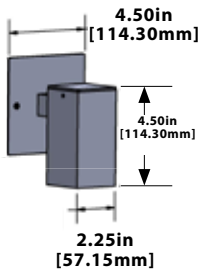

2" X 2" ALUMINUM WALL MOUNT, DOWN LIGHT, 4.5" FLAT PLATE, 12V (SHOWN)							
SL63WMDFP24BLT	ALUMINUM	BLACK TEXTURE	3W MR16 SS LED 36°	3000K/270LM	GU5.3	\$123.20	
SL63WMDFPNLBLT	ALUMINUM	BLACK TEXTURE	NO LAMP		GU5.3	\$93.50	

2" X 2" ALUMINUM WALL MOUNT, DOWN LIGHT, 4.5" FLAT PLATE, 120V							
SL63WMDL108BLT	ALUMINUM	BLACK TEXTURE	3W MR16 SS LED 36°	3000K/270LM	GU10	\$137.50	
SL63WMDGU10NLBLT	ALUMINUM	BLACK TEXTURE	NO LAMP		GU10	\$104.50	

2" X 2" BRASS WALL MOUNT, DOWN LIGHT, 4.5" FLAT PLATE, 12V							
SL63WMDFP24BRS	BRASS	UNFINISHED	3W MR16 SS LED 36°	3000K/270LM	GU5.3	\$224.40	
SL63WMDFP24BRS	BRASS	UNFINISHED	NO LAMP		GU5.3	\$194.70	

2" X 2" BRASS WALL MOUNT, DOWN LIGHT, 4.5" FLAT PLATE, 120V							
SL63WMDL108BRS	BRASS	UNFINISHED	3W MR16 SS LED 36°	3000K/270LM	GU10	\$238.70	
SL63WMDGU10BRS	BRASS	UNFINISHED	NO LAMP		GU10	\$205.70	

FINISHES: (SEE PAGE 49 FOR MORE INFORMATION)							
ADD ON COST FOR OPTIONAL FINISHES						\$11.00	
ADD ON COST FOR PREMIUM COLOR BKM						\$19.80	
ADD ON COST FOR PREMIUM COLOR DBZ						\$17.60	
ADD ON COST FOR ACID TREATMENT OF BRASS						\$33.00	

*NOTE: CUSTOM PRODUCT CONFIGURATIONS, PAINT FINISHES, AND ACID TREATMENTS ARE AVAILABLE; BUT NON RETURNABLE

120V OPTION: (SEE PAGE 51 FOR MORE INFORMATION)							
CHANGE TO GU10 SOCKET - FOR LAMPS: L106, L108, L110, L114, L116, L118, L124, L128						\$11.00	



POWER SUPPLY:							
120V-277V USES P/N HW1260LED277R1 TRANSFORMER INSTALLED IN WEATHERPROOF JUNCTION BOX NO MORE THAN 18' FROM FIXTURE						\$99.00	

12V-277V								CURRENT LIST PRICE USD\$
SL63WM	WALL MOUNT	MATERIAL	FINISH	LED	CCT/LM	SOCKET		

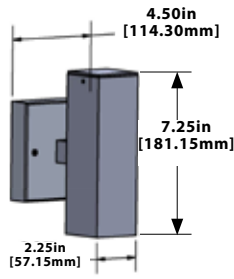

2" X 2" ALUMINUM WALL MOUNT, UP-DOWN LIGHT, 4.5" SQUARE CANOPY, 12V								
SL63WML24BLT		ALUMINUM	BLACK TEXTURE	2X 3W MR16 LED 36°	3000K/540LM	GU5.3		\$180.40
SL63WMNLBLT		ALUMINUM	BLACK TEXTURE	NO LAMP		GU5.3		\$121.00

2" X 2" ALUMINUM WALL MOUNT, UP-DOWN LIGHT, 4.5" SQUARE CANOPY, 120V (SHOWN)								
SL63WML108BLT		ALUMINUM	BLACK TEXTURE	2x 3W MR16 LED 36°	3000K/540LM	GU10		\$209.00
SL63WMGU10NLBLT		ALUMINUM	BLACK TEXTURE	NO LAMP		GU10		\$143.00

2" X 2" BRASS WALL MOUNT, UP-DOWN LIGHT, 4.5" SQUARE CANOPY, 12V								
SL63WML24BRS		BRASS	UNFINISHED	2x 3W MR16 LED 36°	3000K/540LM	GU5.3		\$317.90
SL63WMNLBRS		BRASS	UNFINISHED	NO LAMP		GU5.3		\$258.50

2" X 2" BRASS WALL MOUNT, UP-DOWN LIGHT, 4.5" SQUARE CANOPY, 120V								
SL63WML108BRS		BRASS	UNFINISHED	2x 3W MR16 LED 36°	3000K/540LM	GU10		\$346.50
SL63WMGU10NLBRS		BRASS	UNFINISHED	NO LAMP		GU10		\$280.50

FINISHES: (SEE PAGE 49 FOR MORE INFORMATION)								
ADD ON COST FOR OPTIONAL FINISHES								\$11.00
ADD ON COST FOR PREMIUM COLOR BKM								\$19.80
ADD ON COST FOR PREMIUM COLOR DBZ								\$17.60
ADD ON COST FOR ACID TREATMENT OF BRASS								\$33.00
*NOTE: CUSTOM PRODUCT CONFIGURATIONS, PAINT FINISHES, AND ACID TREATMENTS ARE AVAILABLE; BUT NON RETURNABLE								

120V OPTION: (SEE PAGE 51 FOR MORE INFORMATION)								
CHANGE TO GU10 SOCKET - FOR LAMPS: L106, L108, L110, L114, L116, L118, L124, L128 (PER LAMP X2)								\$11.00



POWER SUPPLY:								
120V-277V USES P/N HW1260LED277R1 TRANSFORMER INSTALLED IN WEATHERPROOF JUNCTION BOX NO MORE THAN 18' FROM FIXTURE								\$99.00

12V-277V								CURRENT LIST PRICE USD\$
SL63WMFP	WALL MOUNT	MATERIAL	FINISH	LED	CCT/LM	SOCKET		

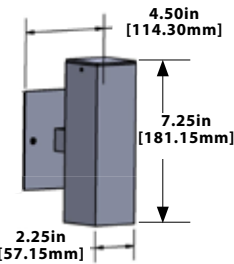

2" X 2" ALUMINUM WALL MOUNT UP-DOWN, 4.5" FLAT PLATE, 12V (SHOWN)								
SL63WMFPL24BLT		ALUMINUM	BLACK TEXTURE	2X 3W MR16 LED 36°	3000K/540LM	GU5.3		\$169.40
SL63WMFPNLBLT		ALUMINUM	BLACK TEXTURE	NO LAMP		GU5.3		\$110.00

2" X 2" ALUMINUM WALL MOUNT UP-DOWN, 4.5" FLAT PLATE, 120V								
SL63WMFPL108BLT		ALUMINUM	BLACK TEXTURE	2x 3W MR16 LED 36°	3000K/540LM	GU10		\$198.00
SL63WMFPGU10NLBLT		ALUMINUM	BLACK TEXTURE	NO LAMP		GU10		\$132.00

2" X 2" BRASS WALL MOUNT UP-DOWN, 4.5" FLAT PLATE, 12V								
SL63WMFPL24BRS		BRASS	UNFINISHED	2x 3W MR16 LED 36°	3000K/540LM	GU5.3		\$287.10
SL63WMFPNLBRS		BRASS	UNFINISHED	NO LAMP		GU5.3		\$227.70

2" X 2" BRASS WALL MOUNT UP-DOWN, 4.5" FLAT PLATE, 120V								
SL63WMFPL108BRS		BRASS	UNFINISHED	2x 3W MR16 LED 36°	3000K/540LM	GU10		\$315.70
SL63WMFPGU10NLBRS		BRASS	UNFINISHED	NO LAMP		GU10		\$249.70

FINISHES: (SEE PAGE 49 FOR MORE INFORMATION)								
ADD ON COST FOR OPTIONAL FINISHES								\$11.00
ADD ON COST FOR PREMIUM COLOR BKM								\$19.80
ADD ON COST FOR PREMIUM COLOR DBZ								\$17.60
ADD ON COST FOR ACID TREATMENT OF BRASS								\$33.00
*NOTE: CUSTOM PRODUCT CONFIGURATIONS, PAINT FINISHES, AND ACID TREATMENTS ARE AVAILABLE; BUT NON RETURNABLE								

120V OPTION: (SEE PAGE 51 FOR MORE INFORMATION)								
CHANGE TO GU10 SOCKET - FOR LAMPS: L106, L108, L110, L114, L116, L118, L124, L128 (PER LAMP X2)								\$11.00



POWER SUPPLY:								
120V-277V USES P/N HW1260LED277R1 TRANSFORMER INSTALLED IN WEATHERPROOF JUNCTION BOX NO MORE THAN 18' FROM FIXTURE								\$99.00

12V-277V	CEILING MOUNT	MATERIAL	FINISH	LED	CCT/LM	SOCKET	CURRENT LIST PRICE USD\$
----------	---------------	----------	--------	-----	--------	--------	--------------------------

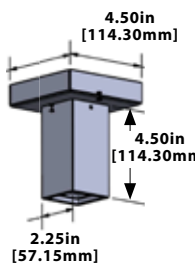

2" X 2" ALUMINUM CEILING MOUNT, DOWN LIGHT, 4.5" SQUARE CANOPY, 12V (SHOWN)							
SL63CML24BLT	ALUMINUM	BLACK TEXTURE	3w MR16 LED 36°	3000K/270LM	GU5.3	\$156.20	
SL63CMNLBLT	ALUMINUM	BLACK TEXTURE	NO LAMP		GU5.3	\$126.50	

2" X 2" ALUMINUM CEILING MOUNT, DOWN LIGHT, 4.5" SQUARE CANOPY, 120V							
SL63CML108BLT	ALUMINUM	BLACK TEXTURE	3w MR16 LED 36°	3000K/270LM	GU10	\$170.50	
SL63CMGU10NLBLT	ALUMINUM	BLACK TEXTURE	NO LAMP		GU10	\$137.50	

2" X 2" BRASS CEILING MOUNT, DOWN LIGHT, 4.5" SQUARE CANOPY, 12V							
SL63CML24BRS	BRASS	UNFINISHED	3w MR16 LED 36°	3000K/270LM	GU5.3	\$275.00	
SL63CMNLBRS	BRASS	UNFINISHED	NO LAMP		GU5.3	\$245.30	

2" X 2" BRASS CEILING MOUNT, DOWN LIGHT, 4.5" SQUARE CANOPY, 120V							
SL63CML108BRS	BRASS	UNFINISHED	3w MR16 LED 36°	3000K/270LM	GU10	\$289.30	
SL63CMGU10NLBRS	BRASS	UNFINISHED	NO LAMP		GU10	\$256.30	

FINISHES: (SEE PAGE 49 FOR MORE INFORMATION)							
ADD ON COST FOR OPTIONAL FINISHES						\$11.00	
ADD ON COST FOR PREMIUM COLOR BKM						\$19.80	
ADD ON COST FOR PREMIUM COLOR DBZ						\$17.60	
ADD ON COST FOR ACID TREATMENT OF BRASS						\$33.00	
*NOTE: CUSTOM PRODUCT CONFIGURATIONS, PAINT FINISHES, AND ACID TREATMENTS ARE AVAILABLE; BUT NON RETURNABLE							

120V OPTION: (SEE PAGE 51 FOR MORE INFORMATION)							
CHANGE TO GU10 SOCKET - FOR LAMPS: L106, L108, L110, L114, L116, L118, L124, L128						\$11.00	



DRIVERS:							
120V-277V USES P/N HW1260LED277R1 DRIVER INSTALLED IN WEATHERPROOF JUNCTION BOX NO MORE THAN 18' FROM FIXTURE						\$99.00	

12V-277V	CEILING MOUNT	MATERIAL	FINISH	LED	CCT/LM	SOCKET	CURRENT LIST PRICE USD\$
----------	---------------	----------	--------	-----	--------	--------	--------------------------

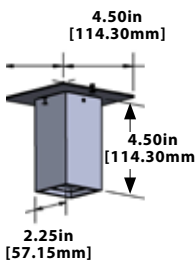

2" X 2" ALUMINUM CEILING MOUNT, DOWN LIGHT, 4.5" FLAT PLATE, 12V (SHOWN)							
SL63CMFPL24BLT	ALUMINUM	BLACK TEXTURE	3w MR16 LED 36°	3000K/270LM	GU5.3	\$145.20	
SL63CMFPNLBLT	ALUMINUM	BLACK TEXTURE	NO LAMP		GU5.3	\$115.50	

2" X 2" ALUMINUM CEILING MOUNT, DOWN LIGHT, 4.5" FLAT PLATE, 120V							
SL63CMFPL108BLT	ALUMINUM	BLACK TEXTURE	3w MR16 LED 36°	3000K/270LM	GU10	\$159.50	
SL63CMFPGU10NLBLT	ALUMINUM	BLACK TEXTURE	NO LAMP		GU10	\$126.50	

2" X 2" BRASS CEILING MOUNT, DOWN LIGHT, 4.5" FLAT PLATE, 12V							
SL63CMFPL24BRS	BRASS	UNFINISHED	3w MR16 LED 36°	3000K/270LM	GU5.3	\$244.20	
SL63CMFPNLBRS	BRASS	UNFINISHED	NO LAMP		GU5.3	\$214.50	

2" X 2" BRASS CEILING MOUNT, DOWN LIGHT, 4.5" FLAT PLATE, 120V							
SL63CMFPL108BRS	BRASS	UNFINISHED	3w MR16 LED 36°	3000K/270LM	GU10	\$258.50	
SL63CMFPGU10NLBRS	BRASS	UNFINISHED	NO LAMP		GU10	\$225.50	

FINISHES: (SEE PAGE 49 FOR MORE INFORMATION)							
ADD ON COST FOR OPTIONAL FINISHES						\$11.00	
ADD ON COST FOR PREMIUM COLOR BKM						\$19.80	
ADD ON COST FOR PREMIUM COLOR DBZ						\$17.60	
ADD ON COST FOR ACID TREATMENT OF BRASS						\$33.00	
*NOTE: CUSTOM PRODUCT CONFIGURATIONS, PAINT FINISHES, AND ACID TREATMENTS ARE AVAILABLE; BUT NON RETURNABLE							

120V OPTION: (SEE PAGE 51 FOR MORE INFORMATION)							
CHANGE TO GU10 SOCKET - FOR LAMPS: L106, L108, L110, L114, L116, L118, L124, L128						\$11.00	



POWER SUPPLY:							
120V-277V USES P/N HW1260LED277R1 TRANSFORMER INSTALLED IN WEATHERPROOF JUNCTION BOX NO MORE THAN 18' FROM FIXTURE						\$99.00	

12V-277V SL63CME	CEILING MOUNT	MATERIAL	FINISH	LED	CCT/LM	SOCKET	CURRENT LIST PRICE USD\$
---------------------	---------------	----------	--------	-----	--------	--------	-----------------------------

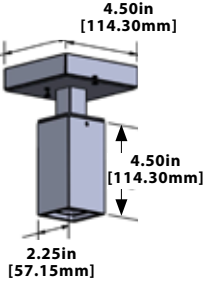

2" X 2" ALUMINUM CEILING MOUNT EXTENSION, DOWN LIGHT, 4.5" SQUARE CANOPY, 12V (SHOWN)							
SL63CME24BLT		ALUMINUM	BLACK TEXTURE	3W MR16 LED 36°	3000K/270LM	GU5.3	\$167.20
SL63CMENLBT		ALUMINUM	BLACK TEXTURE	NO LAMP		GU5.3	\$137.50
2" X 2" ALUMINUM CEILING MOUNT EXTENSION, DOWN, 4.5" SQUARE CANOPY, 120V							
SL63CMEL108BLT		ALUMINUM	BLACK TEXTURE	3W MR16 LED 36°	3000K/270LM	GU10	\$181.50
SL63CMEGU10NLBT		ALUMINUM	BLACK TEXTURE	NO LAMP		GU10	\$137.50
2" X 2" BRASS CEILING MOUNT EXTENSION, DOWN LIGHT, 4.5" SQUARE CANOPY, 12V							
SL63CMEL24BRS		BRASS	UNFINISHED	3W MR16 LED 36°	3000K/270LM	GU5.3	\$297.00
SL63CMEGU10NLBRS		BRASS	UNFINISHED	NO LAMP		GU5.3	\$267.30
2" X 2" BRASS CEILING MOUNT EXTENSION, DOWN LIGHT, 4.5" SQUARE CANOPY, 120V							
SL63CMEL108BRS		BRASS	UNFINISHED	3W MR16 LED 36°	3000K/270LM	GU10	\$311.30
SL63CMENLBR		BRASS	UNFINISHED	NO LAMP		GU10	\$278.30

FINISHES: (SEE PAGE 49 FOR MORE INFORMATION)

ADD ON COST FOR OPTIONAL FINISHES	\$11.00
ADD ON COST FOR PREMIUM COLOR BKM	\$19.80
ADD ON COST FOR PREMIUM COLOR DBZ	\$17.60
ADD ON COST FOR ACID TREATMENT OF BRASS	\$33.00

*NOTE: CUSTOM PRODUCT CONFIGURATIONS, PAINT FINISHES, AND ACID TREATMENTS ARE AVAILABLE; BUT NON RETURNABLE

120V OPTION: (SEE PAGE 51 FOR MORE INFORMATION)

CHANGE TO GU10 SOCKET - FOR LAMPS: L106, L108, L110, L114, L116, L118, L124, L128	\$11.00
---	---------



POWER SUPPLY:

120V-277V USES P/N HW1260LED277R1 TRANSFORMER INSTALLED IN WEATHERPROOF JUNCTION BOX NO MORE THAN 18' FROM FIXTURE	\$99.00
--	---------

12V-277V SL63CMEFP	CEILING MOUNT	MATERIAL	FINISH	LED	CCT/LM	SOCKET	CURRENT LIST PRICE USD\$
-----------------------	---------------	----------	--------	-----	--------	--------	-----------------------------

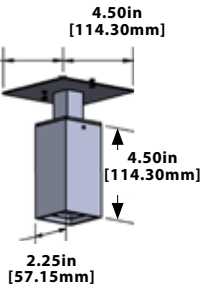

2" X 2" ALUMINUM CEILING MOUNT EXTENSION, DOWN LIGHT. 4.5" FLAT PLATE, 12V (SHOWN)							
SL63CMEFPL24BLT		ALUMINUM	BLACK TEXTURE	3W MR16 LED 36°	3000K/270LM	GU5.3	\$156.20
SL63CMEFPNL12VBLT		ALUMINUM	BLACK TEXTURE	NO LAMP		GU5.3	\$126.50
2" X 2" ALUMINUM CEILING MOUNT EXTENSION, DOWN LIGHT. 4.5" FLAT PLATE, 120V							
SL63CMEFPL108BLT		ALUMINUM	BLACK TEXTURE	3W MR16 LED 36°	3000K/270LM	GU10	\$170.50
SL63CMEFPGU10NLBT		ALUMINUM	BLACK TEXTURE	NO LAMP		GU10	\$137.50
2" X 2" BRASS CEILING MOUNT, DOWN LIGHT, 4.5" FLAT PLATE, 12V							
SL63CMEFPL24BRS		BRASS	UNFINISHED	3W MR16 LED 36°	3000K/270LM	GU5.3	\$266.20
SL63CMEFPGU10NLBRS		BRASS	UNFINISHED	NO LAMP		GU5.3	\$236.50
2" X 2" BRASS CEILING MOUNT, DOWN LIGHT, 4.5" FLAT PLATE, 120V							
SL63CMEFPL108BRS		BRASS	UNFINISHED	3W MR16 LED 36°	3000K/270LM	GU10	\$280.50
SL63CMEFPGU10NLBRS		BRASS	UNFINISHED	NO LAMP		GU10	\$247.50

FINISHES: (SEE PAGE 49 FOR MORE INFORMATION)

ADD ON COST FOR OPTIONAL FINISHES	\$11.00
ADD ON COST FOR PREMIUM COLOR BKM	\$19.80
ADD ON COST FOR PREMIUM COLOR DBZ	\$17.60
ADD ON COST FOR ACID TREATMENT OF BRASS	\$33.00

*NOTE: CUSTOM PRODUCT CONFIGURATIONS, PAINT FINISHES, AND ACID TREATMENTS ARE AVAILABLE; BUT NON RETURNABLE

120V OPTION: (SEE PAGE 51 FOR MORE INFORMATION)

CHANGE TO GU10 SOCKET - FOR LAMPS: L106, L108, L110, L114, L116, L118, L124, L128	\$11.00
---	---------



POWER SUPPLY:

120V-277V USES P/N HW1260LED277R1 TRANSFORMER INSTALLED IN WEATHERPROOF JUNCTION BOX NO MORE THAN 18' FROM FIXTURE	\$99.00
--	---------

120V-277V							CURRENT LIST PRICE USD\$
-----------	--	--	--	--	--	--	--------------------------

SL63LGWM	WALL MOUNT	MATERIAL	FINISH	LED	CCT/LM	SOCKET	
4" X 4" ALUMINUM WALL MOUNT, UP-DOWN LIGHT, 4.5" SQUARE CANOPY, 120V-277V (SHOWN)							
SL63LGWMNLBTL		ALUMINUM	BLACK TEXTURE	NO LAMP		MEDIUM BASE	\$220.00
SL63LGWML142BLT		ALUMINUM	BLACK TEXTURE	2X 8W PAR20 40°	3000K/1,440LM	MEDIUM BASE	\$297.00
4" X 4" BRASS WALL MOUNT, UP-DOWN LIGHT, 4.5" SQUARE CANOPY, 120V-277V							
SL63LGWMNLBRS		BRASS	UNFINISHED	NO LAMP		MEDIUM BASE	\$506.00
SL63LGWML142BRS		BRASS	UNFINISHED	2X 8W PAR20 40°	3000K/1,440LM	MEDIUM BASE	\$583.00
SL63LGWML150BRS		BRASS	UNFINISHED	2X 12W PAR30 40°	3000K/2,160LM	MEDIUM BASE	\$605.00
FINISHES: (SEE PAGE 49 FOR MORE INFORMATION)							
ADD ON COST FOR OPTIONAL FINISHES							\$11.00
ADD ON COST FOR PREMIUM COLOR BKM							\$19.80
ADD ON COST FOR PREMIUM COLOR DBZ							\$17.60
ADD ON COST FOR ACID TREATMENT OF BRASS							\$33.00
*NOTE: CUSTOM PRODUCT CONFIGURATIONS, PAINT FINISHES, AND ACID TREATMENTS ARE AVAILABLE; BUT NON RETURNABLE							

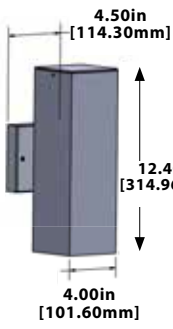

120V-277V							CURRENT LIST PRICE USD\$
-----------	--	--	--	--	--	--	--------------------------

SL63LGWM	WALL MOUNT	MATERIAL	FINISH	LED	CCT/LM	SOCKET	
4" X 4" ALUMINUM WALL MOUNT, DOWN LIGHT, 4.5" SQUARE CANOPY, 120V-277V (SHOWN)							
SL63LGWMDNLBTL		ALUMINUM	BLACK TEXTURE	NO LAMP		MEDIUM BASE	\$172.70
SL63LGWMDL142BLT		ALUMINUM	BLACK TEXTURE	8W PAR20 40°	3000K/720LM	MEDIUM BASE	\$211.20
4" X 4" BRASS WALL MOUNT, DOWN LIGHT, 4.5" SQUARE CANOPY, 120V-277V							
SL63LGWMDNLBRS		BRASS	UNFINISHED	NO LAMP		MEDIUM BASE	\$401.50
SL63LGWMDL142BRS		BRASS	UNFINISHED	8W PAR20 40°	3000K/720LM	MEDIUM BASE	\$440.00
SL63LGWMDL150BRS		BRASS	UNFINISHED	12W PAR30 40°	3000K/1080LM	MEDIUM BASE	\$451.00
FINISHES: (SEE PAGE 49 FOR MORE INFORMATION)							
ADD ON COST FOR OPTIONAL FINISHES							\$11.00
ADD ON COST FOR PREMIUM COLOR BKM							\$19.80
ADD ON COST FOR PREMIUM COLOR DBZ							\$17.60
ADD ON COST FOR ACID TREATMENT OF BRASS							\$33.00
*NOTE: CUSTOM PRODUCT CONFIGURATIONS, PAINT FINISHES, AND ACID TREATMENTS ARE AVAILABLE; BUT NON RETURNABLE							

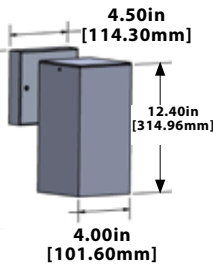

120V-277V							CURRENT LIST PRICE USD\$
-----------	--	--	--	--	--	--	--------------------------

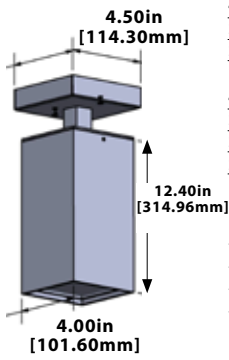

4" X 4" ALUMINUM CEILING MOUNT EXTENSION, DOWN LIGHT, 4.5" SQUARE CANOPY, 120V (SHOWN)							
SL63LGCME	CEILING MOUNT	MATERIAL	FINISH	LED	CCT/LM	SOCKET	
SL63LGCMENLBT		ALUMINUM	BLACK TEXTURE	NO LAMP		MEDIUM BASE	\$170.50
SL63LGCME142BLT		ALUMINUM	BLACK TEXTURE	8W PAR20 40°	3000K/720LM	MEDIUM BASE	\$209.00
4" X 4" BRASS CEILING MOUNT EXTENSION, DOWN LIGHT, 4.5" SQUARE CANOPY, 120V							
SL63LGCME142BRS		BRASS	UNFINISHED	NO LAMP		MEDIUM BASE	\$407.00
SL63LGCME150BRS		BRASS	UNFINISHED	12W PAR30 40°	3000K/1080LM	MEDIUM BASE	\$456.50
FINISHES: (SEE PAGE 49 FOR MORE INFORMATION)							
ADD ON COST FOR OPTIONAL FINISHES							\$11.00
ADD ON COST FOR PREMIUM COLOR BKM							\$19.80
ADD ON COST FOR PREMIUM COLOR DBZ							\$17.60
ADD ON COST FOR ACID TREATMENT OF BRASS							\$33.00
*NOTE: CUSTOM PRODUCT CONFIGURATIONS, PAINT FINISHES, AND ACID TREATMENTS ARE AVAILABLE; BUT NON RETURNABLE							

120V-277V							CURRENT LIST PRICE USD\$
-----------	--	--	--	--	--	--	--------------------------

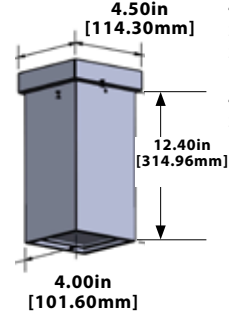

4" X 4" ALUMINUM CEILING MOUNT, DOWN LIGHT, 4.5" SQUARE CANOPY, 120V							
SL63LGCML	CEILING MOUNT	MATERIAL	FINISH	LED	CCT/LM	SOCKET	
SL63LGCMLNLT		ALUMINUM	BLACK TEXTURE	NO LAMP		MEDIUM BASE	\$165.00
SL63LGCML142BLT		ALUMINUM	BLACK TEXTURE	8W PAR20 40°	3000K/720LM	MEDIUM BASE	\$203.50
4" X 4" BRASS CEILING MOUNT, DOWN LIGHT, 4.5" SQUARE CANOPY, 120V (SHOWN)							
SL63LGCMLNLT		BRASS	UNFINISHED	NO LAMP		MEDIUM BASE	\$396.00
SL63LGCML142BRS		BRASS	UNFINISHED	8W PAR20 40°	3000K/270LM	MEDIUM BASE	\$434.50
SL63LGCML150BRS		BRASS	UNFINISHED	12W PAR30 40°	3000K/1080LM	MEDIUM BASE	\$445.50
FINISHES: (SEE PAGE 49 FOR MORE INFORMATION)							
ADD ON COST FOR OPTIONAL FINISHES							\$11.00
ADD ON COST FOR PREMIUM COLOR BKM							\$19.80
ADD ON COST FOR PREMIUM COLOR DBZ							\$17.60
ADD ON COST FOR ACID TREATMENT OF BRASS							\$33.00
*NOTE: CUSTOM PRODUCT CONFIGURATIONS, PAINT FINISHES, AND ACID TREATMENTS ARE AVAILABLE; BUT NON RETURNABLE							

12V SL58	WALL MOUNT	MATERIAL	FINISH	LED	CCT/LM	SOCKET	CURRENT LIST PRICE USD\$
-------------	------------	----------	--------	-----	--------	--------	--------------------------

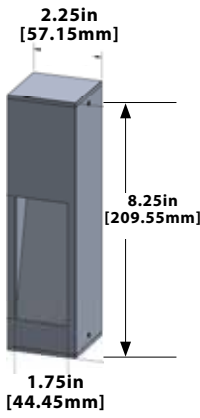

2.25" X 8.25" ALUMINUM VERTICAL WALL MOUNT, 12V							
SL58L12BLT	ALUMINUM	BLACK TEXTURE	3W OMNI SS LED	3000K/300LM	BA15S		\$156.20
SL58L16BLT	ALUMINUM	BLACK TEXTURE	3W OMNI SS LED	3000K/270LM	BA15S		\$158.40
2.25" X 8.25" ALUMINUM VERTICAL WALL MOUNT, TURTLE FRIENDLY, 12V							
SL58L18BLT	ALUMINUM	BLACK TEXTURE	3W OMNI SS LED	3000K/590NM	BA15S		\$158.40
2.25" X 8.25" ALUMINUM VERTICAL WALL MOUNT, LED PANEL, 12V							
SL58LEDPBLT	ALUMINUM	BLACK TEXTURE	4W LED PANEL	3000K/300LM	NONE		\$187.00
2.25" X 8.25" BRASS VERTICAL WALL MOUNT, 12V							
SL58L12BRS	BRASS	UNFINISHED	3W OMNI SS LED	3000K/300LM	BA15S		\$248.60
SL58L16BRS	BRASS	UNFINISHED	3W OMNI SS LED	3000K/270LM	BA15S		\$250.80
2.25" X 8.25" BRASS VERTICAL WALL MOUNT, TURTLE FRIENDLY, 12V							
SL58L18BRS	BRASS	UNFINISHED	3W OMNI SS LED	3000K/590NM	BA15S		\$250.80
2.25" X 8.25" BRASS VERTICAL WALL MOUNT, LED PANEL, 12V							
SL58LEDPBRS	BRASS	UNFINISHED	4W LED PANEL	3000K/300LM	NONE		\$275.00
FINISHES: (SEE PAGE 49 FOR MORE INFORMATION)							
ADD ON COST FOR OPTIONAL FINISHES							\$11.00
ADD ON COST FOR PREMIUM COLOR BKM							\$19.80
ADD ON COST FOR PREMIUM COLOR DBZ							\$17.60
ADD ON COST FOR ACID TREATMENT OF BRASS							\$33.00
*NOTE: CUSTOM PRODUCT CONFIGURATIONS, PAINT FINISHES, AND ACID TREATMENTS ARE AVAILABLE; BUT NON RETURNABLE							
COLOR ACRYLIC LENS OPTIONS:							
FA35SL58AMBER	AMBER ACRYLIC LENS 2" DIA						\$7.70
FA35SL58RED	RED TEMPERED GLASS LENS 2" DIA						\$7.70
FA35SL58BLUE	BLUE TEMPERED GLASS LENS 2" DIA						\$7.70
FA35SL58GREEN	GREEN TEMPERED GLASS LENS 2" DIA						\$7.70

12V SL58SM	SURFACE MOUNT	MATERIAL	FINISH	LED	CCT/LM	SOCKET	CURRENT LIST PRICE USD\$
---------------	---------------	----------	--------	-----	--------	--------	--------------------------

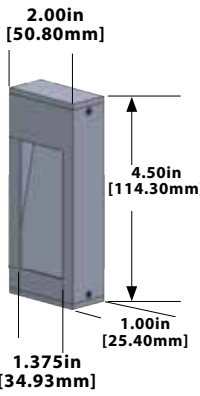

1" X 2" X 4.5" ALUMINUM VERTICAL WALL MOUNT, LED MODULE, 12V							
SL58SMLEDMBLT	ALUMINUM	BLACK TEXTURE	3W LED MODULE	2800K-3000K/285LM	NONE		\$126.50
1" X 2" X 4.5" BRASS VERTICAL WALL MOUNT, LED MODULE, 12V							
SL58SMLEDMBRS	BRASS	UNFINISHED	3W LED MODULE	2800K-3000K/285LM	NONE		\$181.50
FINISHES: (SEE PAGE 49 FOR MORE INFORMATION)							
ADD ON COST FOR OPTIONAL FINISHES							\$11.00
ADD ON COST FOR PREMIUM COLOR BKM							\$19.80
ADD ON COST FOR PREMIUM COLOR DBZ							\$18.70
ADD ON COST FOR ACID TREATMENT OF BRASS							\$33.00
*NOTE: CUSTOM PRODUCT CONFIGURATIONS, PAINT FINISHES, AND ACID TREATMENTS ARE AVAILABLE; BUT NON RETURNABLE							
COLOR ACRYLIC LENS OPTIONS:							
FA35SL58SMAMBER	AMBER ACRYLIC LENS 1 3/4" X 3/4"						\$7.70
FA35SL58SMRED	RED ACRYLIC LENS 1 3/4" X 3/4"						\$7.70
FA35SL58SMBLUE	BLUE ACRYLIC LENS 1 3/4" X 3/4"						\$7.70
FA35SL58SMGREEN	GREEN ACRYLIC LENS 1 3/4" X 3/4"						\$7.70

12V								CURRENT LIST PRICE USD\$
-----	--	--	--	--	--	--	--	--------------------------

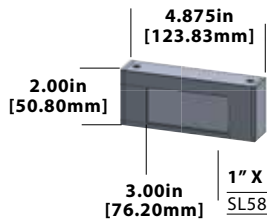

1" X 2" X 4.75" ALUMINUM HORIZONTAL SURFACE MOUNT, LED STRIP, 12V								
SL58SMHORLEDSBLT	ALUMINUM	BLACK TEXTURE	2W LED STRIP	2700K/140LM	NONE			\$93.50
1" X 2" X 4.75" ALUMINUM HORIZONTAL SURFACE MOUNT, TURTLE FRIENDLY LED STRIP, 12V								
SL58SMHORLEDS07WTFBLT	ALUMINUM	BLACK TEXTURE	.7W LED STRIP TF	590NM/10LM	NONE			\$99.00
1" X 2" X 4.75" BRASS HORIZONTAL SURFACE MOUNT, LED STRIP, 12V								
SL58SMHORLEDSBRS	BRASS	UNFINISHED	2W LED STRIP	2800K/150LM	NONE			\$154.00
1" X 2" X 4.75" BRASS HORIZONTAL SURFACE MOUNT, TURTLE FRIENDLY LED STRIP, 12V								
SL58SMHORLEDS07WTFBRS	BRASS	UNFINISHED	.7W LED STRIP TF	590NM/15LM	NONE			\$159.50
FINISHES: (SEE PAGE 49 FOR MORE INFORMATION)								
ADD ON COST FOR OPTIONAL FINISHES								\$11.00
ADD ON COST FOR PREMIUM COLOR BKM								\$19.80
ADD ON COST FOR PREMIUM COLOR DBZ								\$18.70
ADD ON COST FOR ACID TREATMENT OF BRASS								\$33.00
*NOTE: CUSTOM PRODUCT CONFIGURATIONS, PAINT FINISHES, AND ACID TREATMENTS ARE AVAILABLE; BUT NON RETURNABLE								
COLOR ACRYLIC LENS OPTIONS:								
FA35SL58SMAMBER - AMBER ACRYLIC LENS 4" X 9/16"								\$7.70
FA35SL58SMRED - RED ACRYLIC LENS 4" X 9/16"								\$7.70
FA35SL58SMBLUE - BLUE ACRYLIC LENS 4" X 9/16"								\$7.70
FA35SL58SMGREEN - GREEN ACRYLIC LENS 4" X 9/16"								\$7.70

12V								CURRENT LIST PRICE USD\$
-----	--	--	--	--	--	--	--	--------------------------



2.25" X 13.25" ALUMINUM HORIZONTAL SURFACE MOUNT. LED STRIP. 12V								
SL58LGHORLEDSBLT	ALUMINUM	BLACK TEXTURE	4W LED STRIP	2700K/245LM	NONE			\$126.50
2.25" X 13.25" ALUMINUM HORIZONTAL SURFACE MOUNT. TURTLE FRIENDLY. LED STRIP. 2V								
SL58LGHORLEDS2WTFBLT	ALUMINUM	BLACK TEXTURE	2W LED STRIP TF	590NM/30LM	NONE			\$138.69
2.25" X 13.25" BRASS HORIZONTAL SURFACE MOUNT. LED STRIP. 12V								
SL58LGHORLEDSBRS	BRASS	UNFINISHED	4W LED STRIP	2700K/245LM	NONE			\$242.00
2.25" X 13.25" BRASS HORIZONTAL SURFACE MOUNT. TURTLE FRIENDLY. LED STRIP. 12V								
SL58LGHORLEDS2WTFBRS	BRASS	UNFINISHED	2W LED STRIP TF	590NM/30LM	NONE			\$254.10
POWER SUPPLY:								
120V-277V USES P/N HW1260LED277R1 TRANSFORMER INSTALLED IN WEATHERPROOF JUNCTION BOX NO MORE THAN 18' FROM FIXTURE								\$99.00
FINISHES: (SEE PAGE 49 FOR MORE INFORMATION)								
ADD ON COST FOR OPTIONAL FINISHES								\$11.00
ADD ON COST FOR PREMIUM COLOR BKM								\$19.80
ADD ON COST FOR PREMIUM COLOR DBZ								\$18.70
ADD ON COST FOR ACID TREATMENT OF BRASS								\$33.00
*NOTE: CUSTOM PRODUCT CONFIGURATIONS, PAINT FINISHES, AND ACID TREATMENTS ARE AVAILABLE; BUT NON RETURNABLE								
COLOR ACRYLIC LENS OPTIONS:								
FA35SL58LGAMBER - AMBER ACRYLIC LENS 12 1/4" X 9/16"								\$9.35
FA35SL58LGRED - RED ACRYLIC LENS 12 1/4" X 9/16"								\$9.35
FA35SL58LGBLUE - BLUE ACRYLIC LENS 12 1/4" X 9/16"								\$9.35
FA35SL58LGGREEN - GREEN ACRYLIC LENS 12 1/4" X 9/16"								\$9.35

12V SL64SMD	SURFACE MOUNT	MATERIAL	FINISH	LED	CCT/LM	SOCKET	CURRENT LIST PRICE USD\$
----------------	---------------	----------	--------	-----	--------	--------	-----------------------------

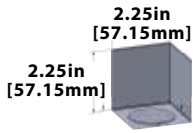

2.25" X 2.25" ALUMINUM SMALL SQUARE SURFACE MOUNT "CUBE," DOWN LIGHT, 12V

SL64SMDL74BLT	ALUMINUM	BLACK TEXTURE	1.5W MR8 LED	3000K/65LM	BI-PIN	\$81.00
SL64SMDL4BLT	ALUMINUM	BLACK TEXTURE	2W OMNI2 MINI	3000K/180LM	BI-PIN	\$75.00
SL64SMDL74BRS	BRASS	UNFINISHED	1.5W MR8 LED	3000K/65LM	BI-PIN	\$115.00
SL64SMDL4BRS	BRASS	UNFINISHED	2W OMNI2 MINI	3000K/180LM	BI-PIN	\$110.00

FINISHES: (SEE PAGE 49 FOR MORE INFORMATION)

ADD ON COST FOR OPTIONAL FINISHES	\$11.00
ADD ON COST FOR PREMIUM COLOR BKM	\$19.80
ADD ON COST FOR PREMIUM COLOR DBZ	\$18.70
ADD ON COST FOR ACID TREATMENT OF BRASS	\$33.00

*NOTE: CUSTOM PRODUCT CONFIGURATIONS, PAINT FINISHES, AND ACID TREATMENTS ARE AVAILABLE; BUT NON RETURNABLE

COLOR ACRYLIC LENS OPTIONS:

FA35SL64SAMBER - AMBER ACRYLIC LENS 3.375" OD X 0.125" ±0.03" TH	\$8.25
FA35SL64SMRED - RED ACRYLIC LENS 3.375" OD X 0.125" ±0.03" TH	\$8.25
FA35SL64SMBLUE - BLUE ACRYLIC LENS 3.375" OD X 0.125" ±0.03" TH	\$8.25
FA35SL64SMGREEN - GREEN ACRYLIC LENS 3.375" OD X 0.125" ±0.03" TH	\$8.25

12V-277V SL64D	SURFACE MOUNT	MATERIAL	FINISH	LED	CCT/LM	SOCKET	CURRENT LIST PRICE USD\$
-------------------	---------------	----------	--------	-----	--------	--------	-----------------------------

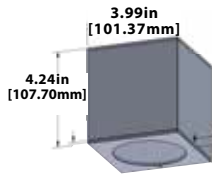

4" X 4" ALUMINUM SQUARE SURFACE MOUNT "CUBE," DOWN LIGHT, 12V

SL64DL24BLT	ALUMINUM	BLACK TEXTURE	3W MR16 SS LED 36°	3000K/270LM	GU5.3	\$127.60
-------------	----------	---------------	--------------------	-------------	-------	----------

4" X 4" ALUMINUM SQUARE SURFACE MOUNT "CUBE," DOWN LIGHT, 120V

SL64DL108BLT	ALUMINUM	BLACK TEXTURE	3W MR16 SS LED 36°	3000K/270LM	GU10	\$156.75
--------------	----------	---------------	--------------------	-------------	------	----------

4" X 4" BRASS SQUARE SURFACE MOUNT "CUBE," DOWN LIGHT, 12V

SL64DL24BRS	BRASS	UNFINISHED	3W MR16 SS LED 36°	3000K/270LM	GU5.3	\$299.20
-------------	-------	------------	--------------------	-------------	-------	----------

4" X 4" BRASS SQUARE SURFACE MOUNT "CUBE," DOWN LIGHT, 120V

SL64DL108BRS	BRASS	UNFINISHED	3W MR16 SS LED 36°	3000K/270LM	GU10	\$377.30
--------------	-------	------------	--------------------	-------------	------	----------

FINISHES: (SEE PAGE 49 FOR MORE INFORMATION)

ADD ON COST FOR OPTIONAL FINISHES	\$11.00
ADD ON COST FOR PREMIUM COLOR BKM	\$19.80
ADD ON COST FOR PREMIUM COLOR DBZ	\$18.70
ADD ON COST FOR ACID TREATMENT OF BRASS	\$33.00

*NOTE: CUSTOM PRODUCT CONFIGURATIONS, PAINT FINISHES, AND ACID TREATMENTS ARE AVAILABLE; BUT NON RETURNABLE

COLOR ACRYLIC LENS OPTIONS:

FA35SL64AMBER - AMBER ACRYLIC LENS 3.375" OD X 0.125" ±0.03" TH	\$8.25
FA35SL64RED - RED ACRYLIC LENS 3.375" OD X 0.125" ±0.03" TH	\$8.25
FA35SL64BLUE - BLUE ACRYLIC LENS 3.375" OD X 0.125" ±0.03" TH	\$8.25
FA35SL64GREEN - GREEN ACRYLIC LENS 3.375" OD X 0.125" ±0.03" TH	\$8.25



POWER SUPPLY:

120V-277V USES P/N HW1260LED277R1 TRANSFORMER INSTALLED IN WEATHERPROOF JUNCTION BOX NO MORE THAN 18' FROM FIXTURE	\$99.00
--	---------

12V-277V SL64	SURFACE MOUNT	MATERIAL	FINISH	LED	CCT/LM	SOCKET	CURRENT LIST PRICE USD\$
------------------	---------------	----------	--------	-----	--------	--------	--------------------------



4" X 4" ALUMINUM SQUARE SURFACE MOUNT "CUBE," UP-DOWN LIGHT, MOUNTING BRACKET, 120V							
SL6426EOSMBLT	ALUMINUM	BLACK TEXTURE	2X 6W EOS MODULE	3000K/1000LM	NONE		\$212.30
4" X 4" ALUMINUM SQUARE SURFACE MOUNT "CUBE," UP-DOWN LIGHT, MOUNTING BRACKET, 120V							
SL64213EOSMBLT	ALUMINUM	BLACK TEXTURE	2X 13W EOS MODULE	3000K/1800LM	NONE		\$226.50
4" X 4" BRASS SQUARE SURFACE MOUNT "CUBE," UP-DOWN LIGHT, MOUNTING BRACKET, 120V							
SL6426EOSMBRS	BRASS	UNFINISHED	2X 6W EOS MODULE	3000K/1000LM	NONE		\$421.30
4" X 4" BRASS SQUARE SURFACE MOUNT "CUBE," UP-DOWN LIGHT, MOUNTING BRACKET, 120V							
SL64213EOSMBTS	BRASS	UNFINISHED	2X 13W EOS MODULE	3000K/1800LM	NONE		\$435.60

FINISHES: (SEE PAGE 49 FOR MORE INFORMATION)

ADD ON COST FOR OPTIONAL FINISHES	\$11.00
ADD ON COST FOR PREMIUM COLOR BKM	\$19.80
ADD ON COST FOR PREMIUM COLOR DBZ	\$18.70
ADD ON COST FOR ACID TREATMENT OF BRASS	\$33.00

*NOTE: CUSTOM PRODUCT CONFIGURATIONS, PAINT FINISHES, AND ACID TREATMENTS ARE AVAILABLE; BUT NON RETURNABLE

COLOR ACRYLIC LENS OPTIONS:

FA35SL64AMBER - AMBER ACRYLIC LENS 3.375" OD X 0.125" ±0.03" TH	\$8.25
FA35SL64RED - RED ACRYLIC LENS 3.375" OD X 0.125" ±0.03" TH	\$8.25
FA35SL64BLUE - BLUE ACRYLIC LENS 3.375" OD X 0.125" ±0.03" TH	\$8.25
FA35SL64GREEN - GREEN ACRYLIC LENS 3.375" OD X 0.125" ±0.03" TH	\$8.25



POWER SUPPLY:

120V-277V USES P/N HW1260LED277R1 TRANSFORMER INSTALLED IN WEATHERPROOF JUNCTION BOX NO MORE THAN 18' FROM FIXTURE	\$99.00
--	---------

12V SL65SM	SURFACE MOUNT	MATERIAL	FINISH	LED	CCT/LM	SOCKET	CURRENT LIST PRICE USD\$
---------------	---------------	----------	--------	-----	--------	--------	--------------------------

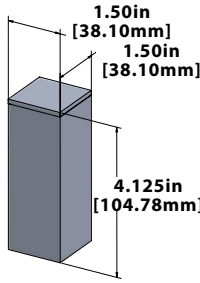

1.5" X 1.5" X 4.125" ALUMINUM SURFACE MOUNT, 12V							
SL65SML12BLT	ALUMINUM	BLACK TEXTURE	3W OMNI SS LED	3000K/300LM	BA15S		\$62.70

FINISHES: (SEE PAGE 49 FOR MORE INFORMATION)

ADD ON COST FOR OPTIONAL FINISHES	\$11.00
ADD ON COST FOR PREMIUM COLOR BKM	\$19.80
ADD ON COST FOR PREMIUM COLOR DBZ	\$18.70
ADD ON COST FOR ACID TREATMENT OF BRASS	\$33.00

*NOTE: CUSTOM PRODUCT CONFIGURATIONS, PAINT FINISHES, AND ACID TREATMENTS ARE AVAILABLE; BUT NON RETURNABLE

12V SL65MD	SURFACE MOUNT	MATERIAL	FINISH	LED	CCT/LM	SOCKET	CURRENT LIST PRICE USD\$
---------------	---------------	----------	--------	-----	--------	--------	--------------------------

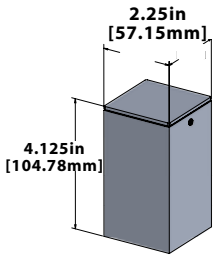

2.25" X 2.25" X 4.125" ALUMINUM SURFACE MOUNT, 12V							
SL65MDL24BLT	ALUMINUM	BLACK TEXTURE	3W MR16 SS LED 36°	3000K/270LM	GU5.3		\$118.20

2.25" X 2.25" X 4.125" BRASS SURFACE MOUNT, 12V							
SL65MDL24BRS	BRASS	UNFINISHED	3W MR16 SS LED 36°	3000K/270LM	GU5.3		\$163.90

FINISHES: (SEE PAGE 49 FOR MORE INFORMATION)

ADD ON COST FOR OPTIONAL FINISHES	\$11.00
ADD ON COST FOR PREMIUM COLOR BKM	\$19.80
ADD ON COST FOR PREMIUM COLOR DBZ	\$18.70
ADD ON COST FOR ACID TREATMENT OF BRASS	\$33.00

*NOTE: CUSTOM PRODUCT CONFIGURATIONS, PAINT FINISHES, AND ACID TREATMENTS ARE AVAILABLE; BUT NON RETURNABLE

COLOR ACRYLIC LENS OPTIONS:

FA35SL58AMBER - AMBER ACRYLIC LENS 2" DIA	\$7.70
FA35SL58RED - RED TEMPERED GLASS LENS 2" DIA	\$7.70
FA35SL58BLUE - BLUE TEMPERED GLASS LENS 2" DIA	\$7.70
FA35SL58GREEN - GREEN TEMPERED GLASS LENS 2" DIA	\$7.70

Finish Options

POWDER COAT / ACID TREATMENT

STANDARD FINISHES



Black Texture
(-BLT)

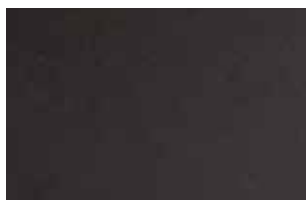

Bronze Texture
(-BRT)

FINISHES:

ADD ON COST FOR OPTIONAL FINISHES	\$11.00
ADD ON COST FOR PREMIUM COLOR BKM	\$19.80
ADD ON COST FOR PREMIUM COLOR DBZ	\$17.60
ADD ON COST FOR ACID TREATMENT OF BRASS/COPPER	\$33.00

Cost may vary based on material and size of fixture.
See product pages for specific pricing.

*Note: All Powder Coat and Acid finishes over Brass or Copper are custom, and non-returnable.

PREMIUM FINISHES

NEW

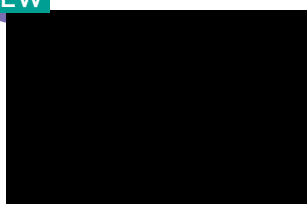

Black Magic
(-BKM)

NEW

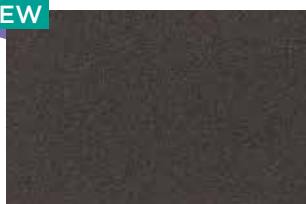

Dark Bronze
(-DBZ)



White Gloss
(-WHT)

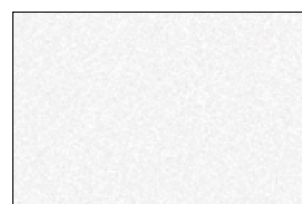

White Texture
(-WTX)



Stucco
(-STU)



Chrome Powder
(-CPR)



Weathered Iron
(-WIR)



Weathered Brown
(-WBR)



Rust
(-RST)



Camel Tone
(-CAM)



Rubbed Verde
(-RBV)



Hunter Texture
(-HTX)

ACID FINISHES (Brass & Copper Fixtures only)



Acid Rust
Copper (-CAR)
Brass (-BAR)

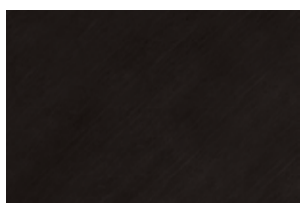

Black Acid Treatment
(-BAT)



Acid Verde
Copper (-CAV)
Brass (-BAV)

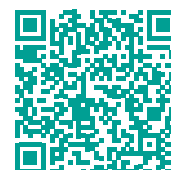

SCAN FOR
DIGITAL VERSION

LED List Guide



go green
led solutions

12V LED 2W OMNI2MINISSBP SUPER SAVER



CATALOG NUMBER	DESCRIPTION	L#	CCT/LUMENS	LED HOURS	CURRENT LIST PRICE USD\$
FLLEDOMNI2MINISSBP	2W, G4 BI-PIN BASE, WARM WHITE, DIMMABLE	L4	3000K/180LM	40,000 HRS	\$18.70

12V LED 3W OMNI / 3W OMNI G2



CATALOG NUMBER	DESCRIPTION	L#	CCT/LUMENS	LED HOURS	CURRENT LIST PRICE USD\$
FLLEDOMNI3SS	3W, SC (SINGLE CONTACT) BA15S BASE, DIMMABLE	L12	3000K/300LM	50,000 HRS	\$17.60



FLLEDOMNI3G2SS27K	3W SC, (SINGLE CONTACT) BA15S BASE DIMMABLE	L15	3000K/270LM	50,000 HRS	\$19.80
FLLEDOMNI3G2SS	3W SC, (SINGLE CONTACT) BA15S BASE DIMMABLE	L16	3000K/270LM	50,000 HRS	\$19.80

12V LED 1.5W MR8 SUPER SAVER



CATALOG NUMBER	DESCRIPTION	L#	CCT/LUMENS	LED HOURS	CURRENT LIST PRICE USD\$
FLLEDMR8NL	1.5W GU4.0 BI-PIN SOCKETS, MR8 LED, 120°	L74	3000K/65LM	25,000 HRS	\$22.00

12V LED 3W MR11 SUPER SAVER



CATALOG NUMBER	DESCRIPTION	L#	CCT/LUMENS	LED HOURS	CURRENT LIST PRICE USD\$
FLLEDMR11SS3W15	3W MR11 GU4 BI-PIN SOCKET LED 15° SPOT, DIMMABLE	L66	3000K/300LM	50,000 HRS	\$33.00
FLLEDMR11SS3W40	3W MR11 GU4 BI-PIN SOCKET LED 40° FLOOD, DIMMABLE	L68	3000K/300LM	50,000 HRS	\$33.00

12V LED 3W/5W/7W MR16 SUPER SAVER



CATALOG NUMBER	DESCRIPTION	L#	CCT/LUMENS	LED HOURS	CURRENT LIST PRICE USD\$
FLLEDMR16SS3W15	3W MR16 GU5.3 BI-PIN SOCKET LED 15° SPOT, DIMMABLE	L22	3000K/300LM	40,000 HRS	\$29.70
FLLEDMR16SS3W36	3W MR16 GU5.3 BI-PIN SOCKET LED 40° FLOOD, DIMMABLE	L24	3000K/300LM	40,000 HRS	\$29.70
FLLEDMR16SS3W80	3W MR16 GU5.3 BI-PIN SOCKET LED 80° FLOOD, 3000K, DIMMABLE	L26	3000K/300LM	40,000 HRS	\$29.70



FLLEDMR16SS5W15	5W MR16 GU5.3 BI-PIN SOCKET LED 15° SPOT, DIMMABLE	L34	3000K/450LM	40,000 HRS	\$30.80
FLLEDMR16SS5W36	5W MR16 GU5.3 BI-PIN SOCKET LED 40° FLOOD, DIMMABLE	L36	3000K/450LM	40,000 HRS	\$30.80
FLLEDMR16SS5W80	5W MR16 GU5.3 BI-PIN SOCKET LED 80° FLOOD, DIMMABLE	L38	3000K/450LM	40,000 HRS	\$30.80
FLLEDMR16SS5W36TF	5W MR16 GU5.3 BI-PIN SOCKET LED 80° FLOOD, DIMMABLE, TF	L40	3000K/150LM	40,000 HRS	\$30.80



FLLEDMR16SS7W15	7W MR16 GU5.3 BI-PIN SOCKET LED 15° SPOT, 3DIMMABLE	L46	3000K/550LM	40,000 HRS	\$33.00
FLLEDMR16SS7W36	7W MR16 GU5.3 BI-PIN SOCKET LED 40° FLOOD, DIMMABLE	L48	3000K/550LM	40,000 HRS	\$33.00
FLLEDMR16SS7W80	7W MR16 GU5.3 BI-PIN SOCKET LED 80° FLOOD, DIMMABLE	L50	3000K/550LM	40,000 HRS	\$33.00

LED List Guide



120V LED	3W/5W/7W MR16 GU10 SUPER SAVER	L#	CCT/LUMENS	LED HOURS	CURRENT LIST PRICE USD\$
----------	--------------------------------	----	------------	-----------	--------------------------



CATALOG NUMBER	DESCRIPTION	L#	CCT/LUMENS	LED HOURS	CURRENT LIST PRICE USD\$
FLLEDMR16SS1203W15	3W MR16 GU10 BASE LED 15° SPOT, 3000K, DIMMABLE	L106	3000K/300LM	40,000 HRS	\$33.00
FLLEDMR16SS1203W36	3W MR16 GU10 BASE LED 40° FLOOD, 3000K, DIMMABLE	L108	3000K/300LM	40,000 HRS	\$33.00
FLLEDMR16SS1203W80	3W MR16 GU10 BASE LED 80° FLOOD, 3000K, DIMMABLE	L110	3000K/300LM	40,000 HRS	\$33.00



FLLEDMR16SS1205W15	5W MR16 GU10 BASE LED 15° SPOT, 3000K, DIMMABLE	L114	3000K/300LM	40,000 HRS	\$33.00
FLLEDMR16SS1205W36	5W MR16 GU10 BASE LED 40° FLOOD, 3000K, DIMMABLE	L116	3000K/300LM	40,000 HRS	\$33.00
FLLEDMR16SS1205W80	5W MR16 GU10 BASE LED 80° FLOOD, 3000K, DIMMABLE	L118	3000K/300LM	40,000 HRS	\$33.00
FLLEDMR16SS5120W36TF	5W MR16 GU10 BASE LED 80° FLOOD, 3000K, DIMMABLE, TF	L119	3000K/300LM	40,000 HRS	\$44.00



FLLEDMR16SS1207W15	7W MR16 GU10 BASE LED 15° SPOT, 3000K, DIMMABLE	L124	3000K/300LM	40,000 HRS	\$33.00
FLLEDMR16SS1207W36	7W MR16 GU10 BASE LED 40° FLOOD, 3000K, DIMMABLE	L126	3000K/300LM	40,000 HRS	\$33.00
FLLEDMR16SS1207W80	7W MR16 GU10 BASE LED 80° FLOOD, 3000K, DIMMABLE	L128	3000K/300LM	40,000 HRS	\$33.00

120V - 277V LED	8W PAR20 / 12W PAR30 / PAR38 SUPER SAVER	L#	CCT/LUMENS	LED HOURS	CURRENT LIST PRICE USD\$
-----------------	--	----	------------	-----------	--------------------------



CATALOG NUMBER	DESCRIPTION	L#	CCT/LUMENS	LED HOURS	CURRENT LIST PRICE USD\$
FLLEDP20SS15	8W PAR20 15° SPOT, WARM WHITE 3000K, MED BASE	L140	3000K/720LM	50,000 HRS	\$38.50
FLLEDP20SS40	8W PAR20 40° FLOOD, WARM WHITE 3000K, MED BASE	L142	3000K/720LM	50,000 HRS	\$38.50



FLLEDP30SS15	12W PAR30 15° SPOT, WARM WHITE, DIMMABLE	L148	3000K/1080LM	50,000 HRS	\$49.50
FLLEDP30SS40	12W PAR 30 40° FLOOD, WARM WHITE, DIMMABLE	L150	3000K/1080LM	50,000 HRS	\$49.50



FLLEDP38SS15	15W PAR38 15° SPOT, WARM WHITE, DIMMABLE	L156	3000K/1350LM	50,000 HRS	\$60.50
FLLEDP38SS40	15W PAR38 40° FLOOD, WARM WHITE, DIMMABLE	L158	3000K/1350LM	50,000 HRS	\$60.50

12V-120V LED	15W AR111 LED	L#	CCT/LUMENS	LED HOURS	CURRENT LIST PRICE USD\$
--------------	---------------	----	------------	-----------	--------------------------



CATALOG NUMBER	DESCRIPTION	L#	CCT/LUMENS	LED HOURS	CURRENT LIST PRICE USD\$
FLLEDP20SS15	15W AR111 15° SPOT, WARM WHITE 3000K, MED BASE	L96	3000K/1350LM	50,000 HRS	\$49.50
FLLEDP20SS40	15W AR111 40° FLOOD, WARM WHITE 3000K, MED BASE	L98	3000K/1350LM	50,000 HRS	\$49.50

12V LED	4W LED PANEL	VOLTAGE	CCT/LUMENS	LED HOURS	CURRENT LIST PRICE USD\$
---------	--------------	---------	------------	-----------	--------------------------



CATALOG NUMBER	DESCRIPTION	VOLTAGE	CCT/LUMENS	LED HOURS	CURRENT LIST PRICE USD\$
RPLEDP4WR	4W LED ROUND "EGG" PANEL	12V	3000K/300LM	50,000 HRS	\$51.70
RPLEDP4WR52	4W LED ROUND "EGG" PANEL	12V	5200K/320LM	50,000 HRS	\$51.70

LED ONLY WORKS WITH DC, USE DRIVER TO CONVERT AC TO DC

HW12535012LED	5W 350mA LED DRIVER AC/DC IN, 12V DC OUT				\$35.20
---------------	--	--	--	--	---------

LED List Guide



12V LED	4W LED MODULE	VOLTAGE	CCT/LUMENS	LED HOURS	CURRENT LIST PRICE USD\$
---------	---------------	---------	------------	-----------	--------------------------



CATALOG NUMBER	DESCRIPTION	VOLTAGE	CCT/LUMENS	LED HOURS	CURRENT LIST PRICE USD\$
RPLEDM3W	3W HALF MOON LED MODULE	12V	2800K/285LM	50,000 HRS	\$85.80

12V LED	7W/11W/15W/20W LED MODULE	VOLTAGE	CCT/LUMENS	LED HOURS	CURRENT LIST PRICE USD\$
---------	---------------------------	---------	------------	-----------	--------------------------



CATALOG NUMBER	DESCRIPTION	VOLTAGE	CCT/LUMENS	LED HOURS	CURRENT LIST PRICE USD\$
RPLEDM7W	REPLACEMENT 7W 12V AC/DC 6 LED MODULE	12V	2800-3000K	50,000 HRS	\$125.40
RPLEDM11W	REPLACEMENT 11W 12V AC/DC 6 LED MODULE	12V	2800-3000K	50,000 HRS	\$136.40
RPLEDM15W	REPLACEMENT 15W 12V AC/DC 6 LED MODULE	12V	2800-3000K	50,000 HRS	\$159.50
RPLEDM20W	REPLACEMENT 20W 12V AC/DC 6 LED MODULE	12V	2800-3000K	50,000 HRS	\$170.50

12V LED	2W LED STRIP	VOLTAGE	CCT/LUMENS	LED HOURS	CURRENT LIST PRICE USD\$
---------	--------------	---------	------------	-----------	--------------------------



CATALOG NUMBER	DESCRIPTION	VOLTAGE	CCT/LUMENS	LED HOURS	CURRENT LIST PRICE USD\$
RPLEDS2W375	2W LED STRIP 3.75" X 0.55"	12V	2700K/140LM	50,000 HRS	\$28.60
RPLEDSSM07WTF	0.7W LED STRIP 3.75" X 0.55" TURTLE FRIENDLY TF	12V	590NM/10LM	50,000 HRS	\$34.10

12V LED	2W LED STRIP	VOLTAGE	CCT/LUMENS	LED HOURS	CURRENT LIST PRICE USD\$
---------	--------------	---------	------------	-----------	--------------------------



CATALOG NUMBER	DESCRIPTION	VOLTAGE	CCT/LUMENS	LED HOURS	CURRENT LIST PRICE USD\$
RPLEDS4W	4W LED STRIP 11.875" X 0.55"	12V	2700K/245LM	50,000 HRS	\$56.10
RPLEDS4WTF	2W LED STRIP 11.875" X 0.55" TURTLE FRIENDLY TF	12V	590NM/30LM	50,000 HRS	\$68.20



landscape • architectural • hospitality • entertainment • illumination

FOCUS LEDS

A GUIDE TO FOCUS INDUSTRIES LEDS



ARROW MR11
12v/2w



SUPER SAVER MR16
12v/3w/5w/7w



SUPER SAVER MR16
120v/3w/5w/7w



OMNI3SS
12v/3w



OMNI3SSG2
12v/3w



OMNI-3 BP
12v/3w



ARROW MR8
12v/1.5w



G4 MINI
12v/2w



PAR16
120v/7w



ARROW PAR38
120v/21w



ARROW PAR20
120v/9w



ARROW PAR30
120v/13w



ARROW PAR36
120v/13w



ARROW AR111
120v/13w

LED MODULES • PANELS & STRIPS



LEDM 12v-120v
7w, 11w, 15w, 20w Module



LEDM 12v/3w Module



Single Diode LED
120v/3w



LEDS 12v/2w Strip



LEDS 12v/4w Strip

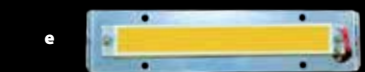
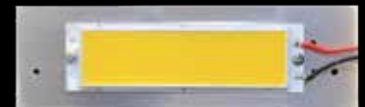

LED DRIVER REFERENCE CHART

Retrofit On board
Module On board
Panel Off board
Strip On board

LED PANELS

- a) 8w Flat Panel
- b) 8w Round Flat Panel
- c) 4w Round Flat Panel
- d) 4w Flat Panel
- e) 5w Flat Panel
- f) 12w Flat Panel



EOS Modules

120v/6w, 13w



120v/277v/12w, 14w, 23w



EOS w/ Optional Magnetic Mounting
120v/13w



landscape • architectural • hospitality • entertainment • illumination

go green
led solutions



NEW SurfaceMounts

Model Shown:
SL63WMDL24BKM



NEW AL08 SERIES 2 BOLLARDS

with Frosted Acrylic Accent



NEW Hanging FIXTURES SERIES

Same Focus Product. New Accents.



landscape • architectural • hospitality • entertainment • illumination



DESIGNED
MANUFACTURED
IN THE USA

SEE MORE AT:
WWW.FOCUSINDUSTRIES.COM

TO PLACE ORDERS:
ORDERS@FOCUSINDUSTRIES.COM
TOLL FREE (888)882.1350