

# DL20 MR16 DIRECTIONAL LIGHT SPEC SHEET

DL20MR16

PROJECT: \_\_\_\_\_ TYPE: \_\_\_\_\_ DATE: \_\_\_\_\_  
 CATALOG NUMBER: \_\_\_\_\_



DL20MR16L24BLT  
(Extended Cap Version)



DL20ACMR16L24BLT  
(Angeled Cap Version)

## CATALOG ORDER LOGIC

EXAMPLE: DL20MR16L24BLT

## FIXTURE

DL Directional Light

## TYPE

20MR16

## DOWN LIGHT OPTION

D

## CAP OPTION

EC Extended Cap (Standard)  
 AC Angled Cap

12 VOLT LED	WATT	SOCKET	DEGREE	KELVIN	LUMEN
<input type="checkbox"/> NL (No Lamp)					
<input type="checkbox"/> NLBP (No Lamp)		GU5.3 Bi-Pin			
<input type="checkbox"/> L22	3w	GU5.3 Bi-Pin	15°	3000K	270lm
<input type="checkbox"/> L24	3w	GU5.3 Bi-Pin	36°	3000K	270lm
<input type="checkbox"/> L26	3w	GU5.3 Bi-Pin	80°	3000K	270lm
<input type="checkbox"/> L34	5w	GU5.3 Bi-Pin	15°	3000K	450lm
<input type="checkbox"/> L36	5w	GU5.3 Bi-Pin	36°	3000K	450lm
<input type="checkbox"/> L38	5w	GU5.3 Bi-Pin	80°	3000K	450lm
<input type="checkbox"/> L40	5w	GU5.3 Bi-Pin	36°	Amber	585-595nm
<input type="checkbox"/> L46	7w	GU5.3 Bi-Pin	15°	3000K	550lm
<input type="checkbox"/> L48	7w	GU5.3 Bi-Pin	36°	3000K	550lm
<input type="checkbox"/> L50	7w	GU5.3 Bi-Pin	80°	3000K	550lm

120 VOLT LED	WATT	SOCKET	DEGREE	KELVIN	LUMEN
<input type="checkbox"/> NL (No Lamp)					
<input type="checkbox"/> NL120V		GU10			
<input type="checkbox"/> L106	3w	GU10	15°	3000K	270lm
<input type="checkbox"/> L108	3w	GU10	36°	3000K	270lm
<input type="checkbox"/> L110	3w	GU10	80°	3000K	270lm
<input type="checkbox"/> L114	5w	GU10	15°	3000K	450lm
<input type="checkbox"/> L116	5w	GU10	36°	3000K	450lm
<input type="checkbox"/> L118	5w	GU10	80°	3000K	450lm
<input type="checkbox"/> L119	5w	GU10	36°	Amber	585-595nm
<input type="checkbox"/> L124	7w	GU10	15°	3000K	550lm
<input type="checkbox"/> L126	7w	GU10	36°	3000K	550lm
<input type="checkbox"/> L128	7w	GU10	80°	3000K	550lm

## OPTIONS

NS No Stake  
 25F 25 Foot Fixture Lead Wire

## FINISH (standard finishes listed)

BLT Black Texture (Standard) More powder coat options, see page 4  
 BRT Bronze Texture (Standard) More powder coat options, see page 4  
 BRS (Unfinished- Brass)  
 Composite (Unfinished-Bronze or Black Composite)

Premium and Acid Finishes (See page 4 for more color options)  
 Pantone & RAL Colors (Enter RAL or Pantone number at end of part number)

## SHIP WEIGHT

Aluminum 6100 (2.0lbs)  
 Brass C27200 (3.0lbs)  
 Composite (1.0lbs)

## ADDITIONAL INFORMATION

• LED's are dimmable with Triac dimming



IP65



Click Icon to Download



landscape • architectural • hospitality • entertainment • illumination

**FOCUS INDUSTRIES INC.**  
 25301 COMMERCENTRE DRIVE  
 LAKE FOREST, CA. 92630  
 949.830.1350 | TOLL FREE: 888.882.1350  
 WWW.FOCUSINDUSTRIES.COM

DESIGNED  
 MANUFACTURED  
 IN THE USA



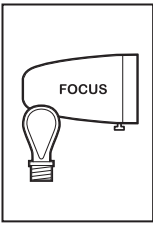

# DL20 MR16 DIRECTIONAL LIGHT SPEC SHEET

DL20MR16

PROJECT:

TYPE:

DATE:

CATALOG NUMBER:

## DIMENSIONS

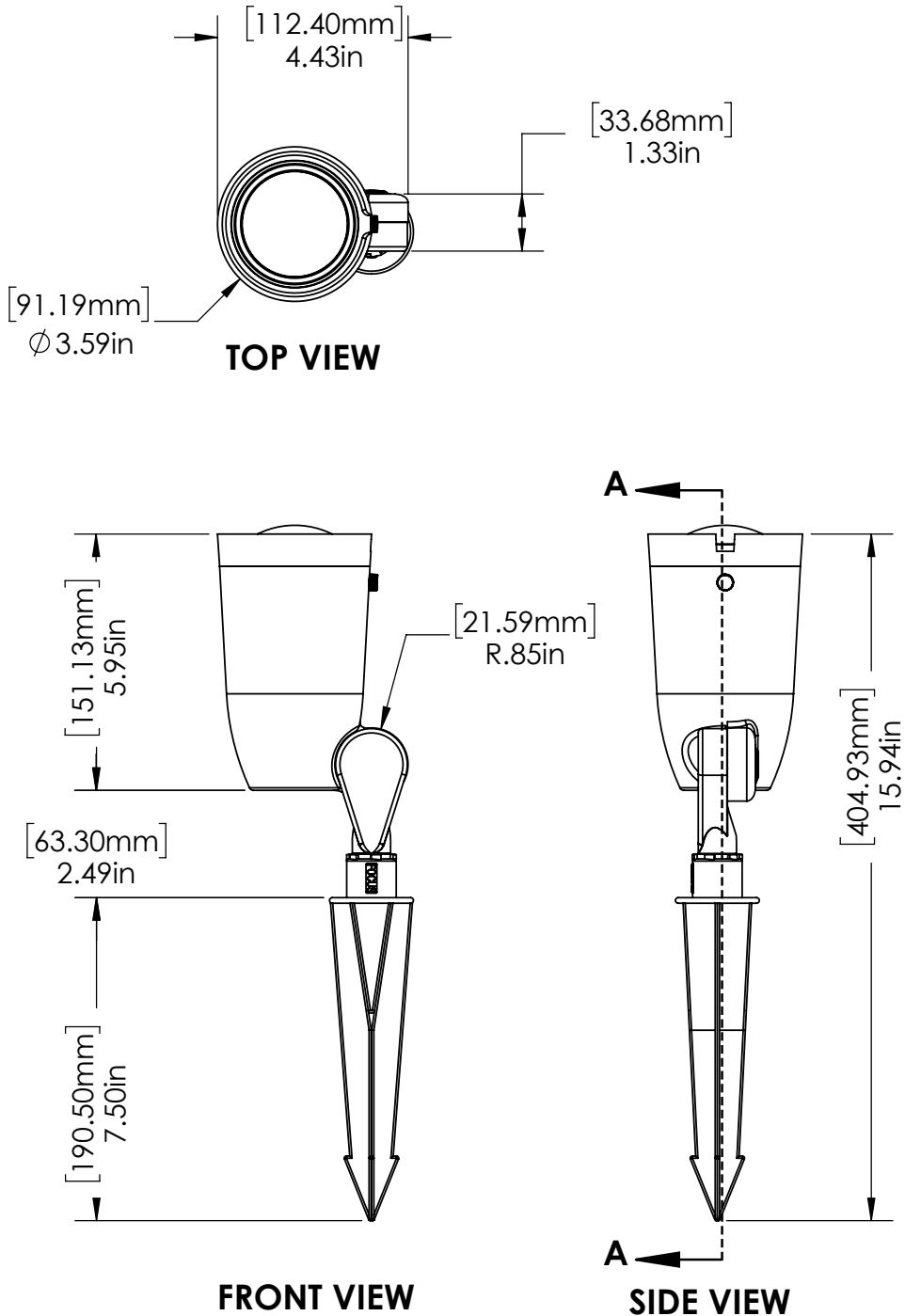

IP65



landscape • architectural • hospitality • entertainment • illumination

**FOCUS INDUSTRIES INC.**  
 25301 COMMERCENTRE DRIVE  
 LAKE FOREST, CA. 92630  
 949.830.1350 | TOLL FREE: 888.882.1350  
 WWW.FOCUSINDUSTRIES.COM

DESIGNED  
MANUFACTURED  
IN THE USA



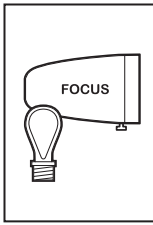

# DL20 MR16 DIRECTIONAL LIGHT SPEC SHEET

DL20MR16

PROJECT:	TYPE:	DATE:
CATALOG NUMBER:		

## SPECIFICATIONS

INTERNALS	VOLTAGE	12 Volt / 120 Volt
	WIRING	12 Volt: Standard black 3ft 18/2 zip cord from base of fixture. 120 Volt: Standard 18g, black, white, green (ground)
	O-RING	Red silicone, 70 durometer, 568-149
EXTERNALS	BODY	Cast aluminum, brass or composite bullet, 3.59" OD x 5.95" (Dimensions include standard length with EC cap)
	CAP(S)	Cast aluminum, brass or composite (Extension Cap EC: 3.50" OD x 0.75"), (Angled Cap AC: 3.50" OD x 3.50")
	LENS	Glass lens, clear tempered convex, 2.80" OD x .775" ±0.03"
	SWIVEL	Adjustable cast brass top and bottom swivel, 240° rotation, screw, lock nut, .50"NPS
	MOUNT	Aluminum: FA03 ABS black stake, .50" NPS tapped. Low voltage only. (More options available. See page 3.) Brass: FA03LG ABS black stake, .50" NPS tapped. Low voltage only. (More options available. See page 3.) Composite: FA03 ABS black stake, .50" NPS tapped. Low voltage only. (More options available. See page 3.)
	FINISH	Aluminum: Black or Bronze Texture (Standard) See page 5 for more powder coat options. Brass: Unfinished (Standard) See page 5 for more powder coat and acid treatment options. Composite:
	LISTINGS	ETL, IP65, CE IES files available for download.



Click Icon to Download



**FOCUS INDUSTRIES INC.**  
 25301 COMMERCENTRE DRIVE  
 LAKE FOREST, CA. 92630  
 949.830.1350 | TOLL FREE: 888.882.1350  
 WWW.FOCUSINDUSTRIES.COM



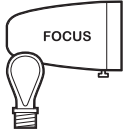

# DL20 MR16 DIRECTIONAL LIGHT SPEC SHEET

DL20MR16

PROJECT:

TYPE:

DATE:

CATALOG NUMBER:

## ACCESSORIES

(Configure and order accessories separately)

### Stakes



FA03 8.75" (12v)	FA03LG 8.875" (12v)	FA03RX 7.00" (12v)	FA032P 8.235" (12v)	FA033P 8.235" (12v)
------------------------	---------------------------	--------------------------	---------------------------	---------------------------

### Mounting Posts

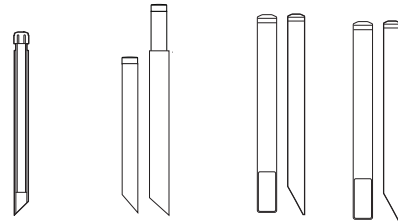

FA01 15.00" (12v)	FA24MDCSTPOST 13.00" to 16.00" (12v)	FA25 20.00" (12v)	FA26 20.00" (120-277v)
-------------------------	--	-------------------------	------------------------------

### Extension Wands & Couplers

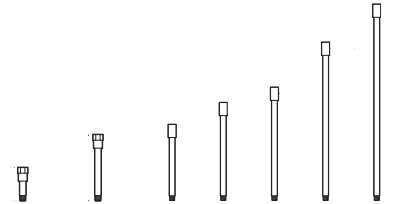

FA30-4 4.00"	FA30-8 8.00"	FA30 10.00"	FA31 13.00"	FA32 16.00"	FA33 21.00"	FA34 26.00"
(12-277v)						

### Canopies & Adapters



FA24/BRS 3.00" dia. (12v)	FA24MDCST/BRS 2.65" dia. (12v)	FA24MDCSTPC/BRS 2.65" dia. (12v)	FA24MD (12v)	FA24LGSPUN/BRS 4.75" dia. (12v)	FA24LGCST/BRS 4.75" dia. (12-277v)
---------------------------------	--------------------------------------	--	-----------------	---------------------------------------	--



FA24LGDHBR (12-277v)	FA23CST (12-277v)	FATAD (12-277v)	FA22LGCST/BRS 5.75" (12-277v)
-------------------------	----------------------	--------------------	-------------------------------------

### Tree Mounts

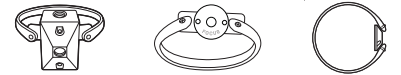

FA22TREE (12-277v)	FA24MDCSTTREE (12v)	FA24T (12v)
-----------------------	------------------------	----------------

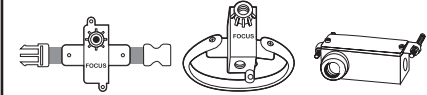

C/FA111TPS (12-277v)	C/FA111T (120-277v)	C/FA111 (12-277v)
-------------------------	------------------------	----------------------

### Lenses



FA11BLUE (Color Glass Lens)	FA11GREEN (Color Glass Lens)	FA11AMBER (Color Glass Lens)	FA11RED (Color Glass Lens)
--------------------------------	---------------------------------	---------------------------------	-------------------------------



FA104SB (Sand Blasted Lens)	FA98 (Linear Lens)	FA0821 (Hex Cell Louver)
--------------------------------	-----------------------	-----------------------------

### Direct Burials & JBoxes



DBR55JB (12-277v)	FA-JBOX (12-277v)
----------------------	----------------------



IP65



landscape • architectural • hospitality • entertainment • illumination

#### FOCUS INDUSTRIES INC.

25301 COMMERCENTRE DRIVE  
LAKE FOREST, CA. 92630  
949.830.1350 | TOLL FREE: 888.882.1350  
WWW.FOCUSINDUSTRIES.COM

DESIGNED  
MANUFACTURED  
IN THE USA



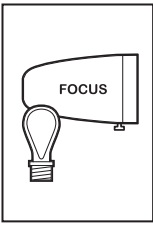

# DL20 MR16 DIRECTIONAL LIGHT SPEC SHEET

DL20MR16

PROJECT:	TYPE:	DATE:
CATALOG NUMBER:		

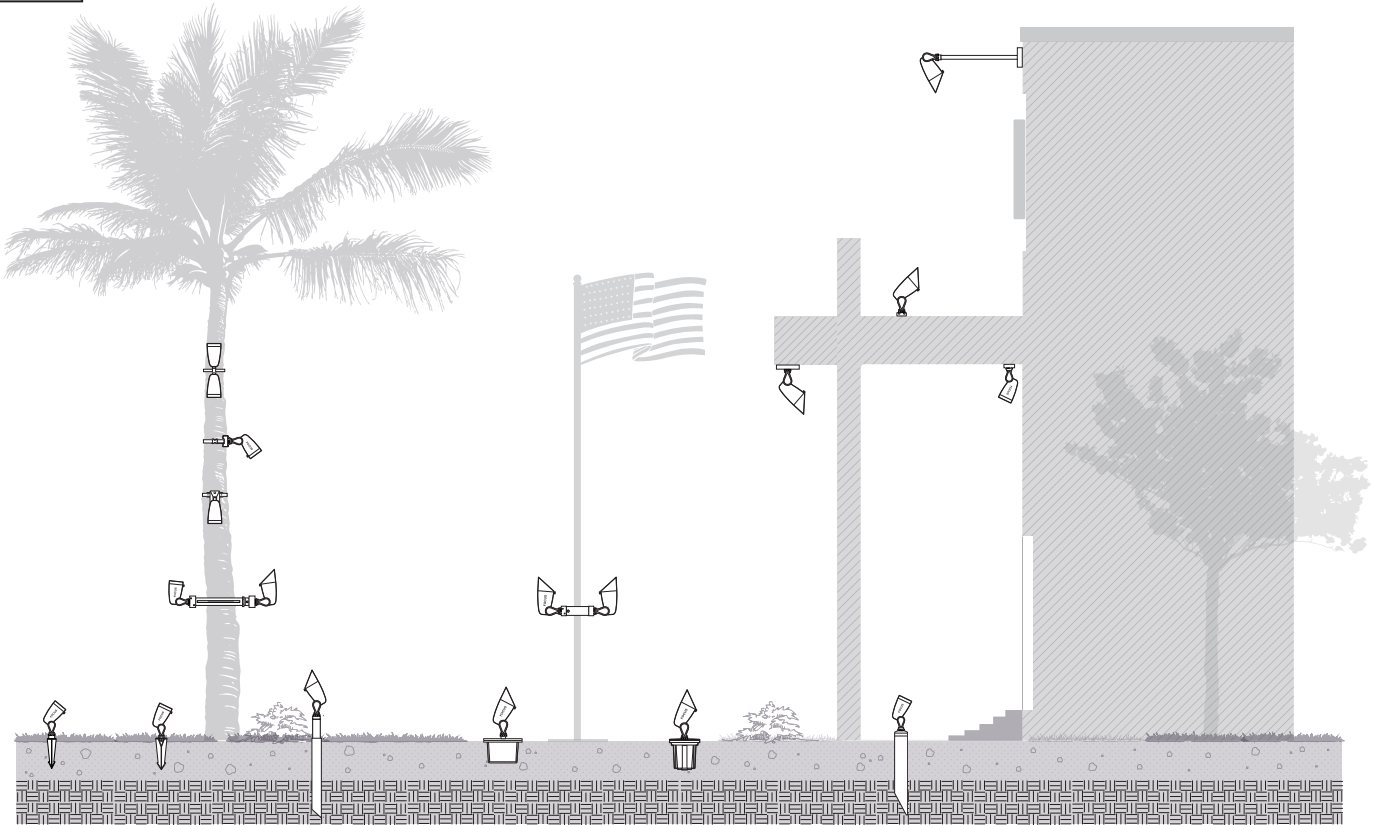

Images enhanced to illustrate usage of mounting options. Drawings not to scale. (See page 2 for product dimensions)  
 (Use like material of fixture with material of mounting device for better compatibility)

## FINISHES

### STANDARD FINISHES

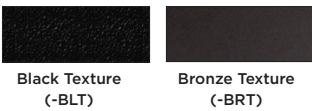

### PREMIUM FINISHES



### CUSTOM FINISHES

Supply RAL or Pantone here

**RAL #:**  
 Need help finding a RAL color?  
<https://www.ralcolor.com/>

**PANTONE #:**  
 Need help finding a Pantone color?  
<https://www.pantone.com/color-finder>

### ACID FINISHES

Brass and Copper fixtures only



SCAN FOR FULL SIZE  
 COLOR SWATCHES



**FOCUS INDUSTRIES INC.**  
 25301 COMMERCENTRE DRIVE  
 LAKE FOREST, CA. 92630  
 949.830.1350 | TOLL FREE: 888.882.1350  
 WWW.FOCUSINDUSTRIES.COM

