



DIRECTIONAL LIGHTS DL-22 120V SERIES



TYPE



SPECIFICATIONS

CONSTRUCTION: Cast aluminum, brass or 316 Stainless Steel Bullet; matching heavy duty cast aluminum, brass or 316 Stainless Steel adjustable swivel

LENS: High impact clear tempered convex glass

O-RING: High temperature red silicone

LAMP SUPPLIED: 35w MR16 Med Base FL 30°; 2000 hours maximum rating (35w max)

LAMP OPTIONS: We recommend 120v 4w ARROW GU10 LED 50,000 average rating

SOCKET: Med Base - high temperature ceramic medium base with 250°C silicone lead wires; GU10 - high temperature GU10 two pin base with 250°C silicone lead wires

WIRING: Standard 120 volt Black, White and Ground 9" lead wires

MOUNTING: None supplied. See Mounting Accessories below for options

FINISH: Aluminum-Black texture polyester powder coat. Optional finishes available
Brass-Unfinished brass. Optional finishes available



DL-22-120VLED-BRT
mounted on
FA-26-BRT

ORDERING INFORMATION

CATALOG NO.	DESCRIPTION	LAMP	SHIP WEIGHT
DL-22-120V-BLT	Cast aluminum Bullet	35w MR16 FL(30°)	2.0 lbs.
DL-22-120V-BRS	Cast brass Bullet	35w MR16 FL(30°)	3.0 lbs.
DL-22-120V-SS	Cast Stainless Steel Bullet	35w MR16 FL(30°)	2.0 lbs.
DL-22-NL120V-BLT	Cast aluminum Bullet	No Lamp Med Base	2.0 lbs.
DL-22-NL120V-BRS	Cast brass Bullet	No Lamp Med Base	3.0 lbs.
DL-22-NL120V-SS	Cast Stainless Steel Bullet	No Lamp Med Base	2.0 lbs.
DL-22-120VLED-BLT	Cast aluminum Bullet	4w MR16 LED FL(BAB)	2.0 lbs.
DL-22-120VLED-BRS	Cast brass Bullet	4w MR16 LED FL(BAB)	3.0 lbs.
DL-22-120VLED-SS	Cast Stainless Steel Bullet	4w MR16 LED FL(BAB)	2.0 lbs.
DL-22-NL120VLED-BLT	Cast aluminum Bullet	No Lamp GU10 socket	2.0 lbs.
DL-22-NL120VLED-BRS	Cast brass Bullet	No Lamp GU10 socket	3.0 lbs.
DL-22-NL120VLED-SS	Cast Stainless Steel Bullet	No Lamp GU10 socket	2.0 lbs.

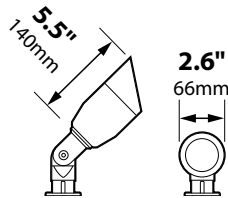

BEAM/GLARE CONTROL ACCESSORIES

FA-08-21	Round 1/8" Hex Cell Louver
FA-11-BLUE	Blue Tempered Glass Lens
FA-11-GREEN	Green Tempered Glass Lens
FA-98	Linear Spread Tempered Glass Lens
FA-99	High Impact Clear Tempered Convex Glass
FA-104	Wide Spread Tempered Glass Lens Softener



JOB INFORMATION

Type:	Date:
Job Name:	
Cat. No.:	
Lamp(s):	
Specifier:	
Contractor:	
Notes:	

FOCUS INDUSTRIES INC. 25301 COMMERCENTRE DRIVE LAKE FOREST, CA 92630
www.focusindustries.com sales@focusindustries.com (949) 830-1350 • FAX (949) 830-3390

Black Texture (Standard)	Antique Verde	Bronze Texture	Camel	White Texture	Hunter Texture	Rust	Weathered Iron	Weathered Brown	Stucco	Rubbed Verde	Chrome Powder	Acid Rust	Acid Verde	Black Acid Treatment
-BLT	-ATV	-BRT	-CAM	-WTX	-HTX	-RST	-WIR	-WBR	-STU	-RBV	-CPR	-BAR/CAR	-BAV/CAV	-BAT



DIRECTIONAL LIGHTS DL-22 120V SERIES



TYPE



MOUNTING ACCESSORIES

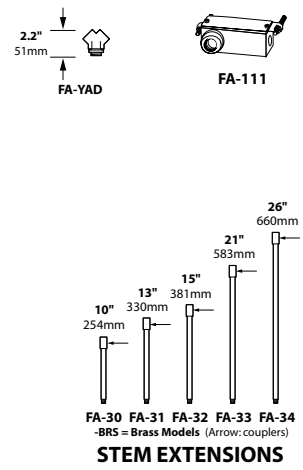
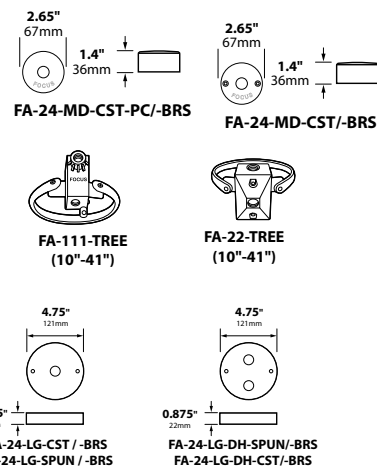
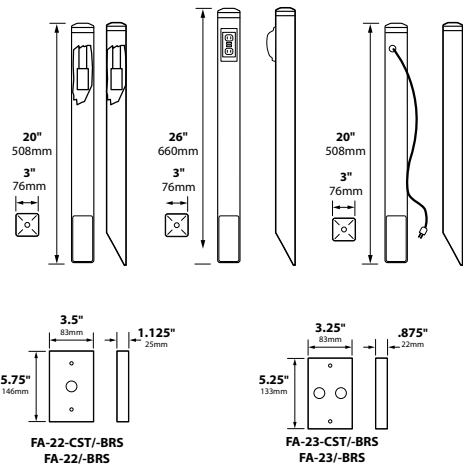

LIGHT DISTRIBUTIONS AND PHOTOMETRICS

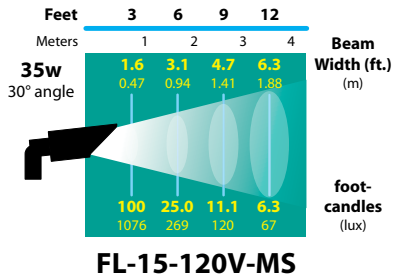

FL-15-120V-MS

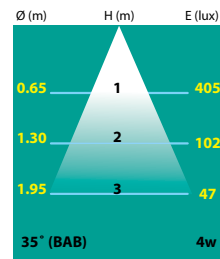

FL-LED-MR16-BAB

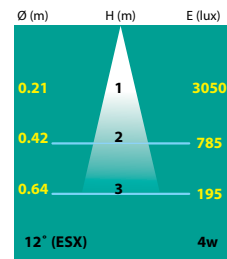

FL-LED-MR16-ESX

Black Texture (Standard)	Antique Verde	Bronze Texture	Camel	White Texture	Hunter Texture	Rust	Weathered Iron	Weathered Brown	Stucco	Rubbed Verde	Chrome Powder	Acid Rust	Acid Verde	Black Acid Treatment
-BLT	-ATV	-BRT	-CAM	-WTX	-HTX	-RST	-WIR	-WBR	-STU	-RBV	-CPR	-BAR/CAR	-BAV/CAV	-BAT